

# SHARP®

MODEL

**AR-651**  
**AR-810**

**DIGITAL COPYING MACHINE**

OPERATION MANUAL

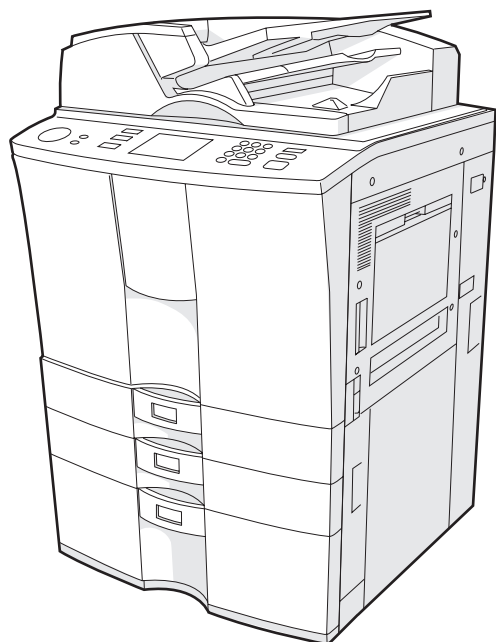

The power switch positions are marked “Ⓜ” to indicate power “ON” and “Ⓜ” to indicate stand-by.

In the stand-by position, power is being supplied to a drying heater within the optical system of the copier.

**Caution:**

For complete electrical disconnection, pull out the main plug.

The socket-outlet shall be installed near the equipment and shall be easily accessible.

**FOR YOUR RECORDS ...**

To protect against loss or theft, record and retain for reference the copier's serial number located on the left hand side at the rear corner of the copier.

Model Number \_\_\_\_\_

Serial Number \_\_\_\_\_

Date of Purchase \_\_\_\_\_

Place of Purchase \_\_\_\_\_

Authorized Sharp Copier

Service Department Number \_\_\_\_\_

***FCC NOTICE***

This equipment has been tested and found to comply with the limits for a Class A digital device, pursuant to Part 15 of the FCC Rules. These limits are designed to provide reasonable protection against harmful interference when the equipment is operated in a commercial environment. This equipment generates, uses, and can radiate radio frequency energy and, if not installed and used in accordance with the instruction manual, may cause harmful interference to radio communications. Operation of this equipment in a residential area is likely to cause harmful interference in which case the user will be required to correct the interference at his own expense.

**WARNING:**

FCC Regulations state that any unauthorized changes or modifications to this equipment not expressly approved by the manufacturer could void the user's authority to operate this equipment.

This Class A digital apparatus complies with Canadian ICES-003.

Cet appareil numérique de la classe A est conforme à la norme NMB-003 du Canada.

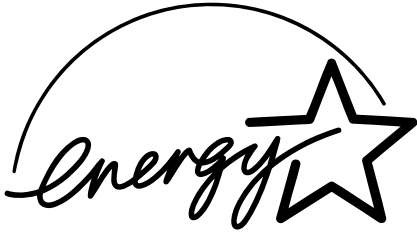

## EPA ENERGY STAR® (MFD)

The United States Environmental Protection Agency (EPA) has introduced a voluntary program, the ENERGY STAR Program, to encourage the widespread and voluntary use of energy-efficient technologies that enhance the workplace, improve product performance and prevent pollution. As an ENERGY STAR Partner, the SHARP Corp. has determined that this copier model meets the ENERGY STAR guidelines for energy efficiency.

ENERGY STAR guidelines for this class of copier require ENERGY STAR copiers to have an 'Off Mode' feature that automatically turns the copier off after a period of inactivity, ensuring night and weekend shut-off. The copier must also automatically change to a 'Low Power Mode' (Automatic Energy Save) after a period of time since the last usage.

For Copier+Printer models, ENERGY STAR guidelines require ENERGY STAR Multifunction copiers to have a 'Sleep Mode' feature that automatically makes the copier enter the sleep mode after a period of inactivity. The copier must also automatically change to a 'Low Power Mode' (Automatic Energy Save) after a period of time since the last usage.

Specifically, this copier complies with the following requirements —

◇ **The AR-651/810 Copier model (Base model)**

**'Off Mode'-**

The copier consumes less than 20 watts in the 'Off Mode'.

**'Off Mode' Default Time-**

The default time for the 'Off Mode' is 90 minutes.

**'Automatic Energy Save'-**

The copier consumes less than 255 watts (AR-651)/ 316 watts (AR-810) while in Energy Save Mode.

**'Automatic Energy Save' Default Time-**

The default time before switching to 'Automatic Energy Save Mode' is 15 minutes.

◇ **The AR-651/810 Copier + Printer model (Multifunction model)**

**'Sleep Mode'-**

The copier consumes less than 95 watts in the 'Sleep Mode'.

**'Sleep Mode' Default Time-**

The default time while in 'Sleep Mode Mode' is 90 minutes.

**'Automatic Energy Save'-**

The copier consumes less than 300 watts (AR-651)/ 361 watts (AR-810) while in Energy Save Mode.

**'Automatic Energy Save' Default Time-**

The default time before switching to 'Automatic Energy Save Mode' is 15 minutes.

**Note1-** The default setting for the 'Off Mode' or 'Sleep Mode' and 'Automatic Energy save' can be changed.

**Note2-** To restart the copier after auto shutoff, turn on the power switch. To restart the copier after sleep mode, press the start key.

**Note3-** In the sleep mode, if printer data is received, or the start key on the control panel is pressed, the copier starts warming itself up and prints out the data when it becomes ready.

If you have any questions regarding the use of recycled paper or some recommended types of recycled paper, please contact your authorized Sharp dealer.

ENERGY STAR is a U. S. registered mark.

# PREFACE

---

Thank you for purchasing the Sharp Digital Copier AR-651/810. This Operator's Manual describes the following:

- how to use the digital copier
- how to inspect and carry out maintenance on the digital copier
- how to remedy mechanical and copying problems

Before using the digital copier, thoroughly read and understand this Operator's Manual. To ensure that clean copies are made at all times and to keep your digital copier in optimum working order, this Operator's Manual should be readily available for future reference.

■ To ensure correct and safe use of the Sharp Digital Copier AR-651/810, this Operator's Manual describes safety precautions according to the following three levels of warning:

Before reading this Operator's Manual, you should fully understand the meaning and importance of these signal words.

Warning .. Indicates a potentially hazardous situation which, if not avoided, could result in death, serious injury, or serious damage, or fire in the equipment or surrounding assets.

Caution ... Indicates a potentially hazardous situation which, if not avoided, may result in minor or moderate injury, partial damage of the equipment or surrounding assets, or loss of data.

Note ..... Indicates a procedure you should follow to ensure the optimal performance of the digital copier and problem-free copying.

Tip ..... Describes handy information that is useful to know when operating the digital copier.

Advice ..... Describes an operation you should follow to keep the digital copier in good working order.

## User Safety

This Sharp digital plain paper copier does not produce laser radiation hazardous to the user. It is certified as a Class 1 laser product under the U.S. Department of Health and Human Services (DHHS) Radiation Performance Standard according to the Radiation Control for Health and Safety Act of 1968.

Protective housing and external covers completely confine the laser light emitted inside the plain paper copier. The laser beam cannot escape from the machine during any phase of user operation.

Regulations implemented on August 2, 1976 by the Bureau of Radiological Health (BRH) of the U.S. Food and Drug Administration apply to laser products manufactured from August 1, 1976. Laser products marketed in the United States must comply with these regulations.

**CAUTION:** Using controls or adjustments or performing procedures, other than those specified herein may result in hazardous radiation exposure.

## PREFACE (Cont.)

### Features of the AR-651/810

---

The AR-651/810 is a digital copier which is high-speed, compact and high-durability. The AR-651/810 can read the image in the memory temporarily after scanning, so you can operate sorting/grouping, etc. as well as processing/editing quietly, quickly and easily. And the combination of various finishing function such as thick paper and tab paper, etc. makes finishing easier as you request.

The AR-651/810 also has the following convenient features, functions and options.

- The copying speed is 65 copies (LT) per minute for the AR-651 and 81 copies (LT) per minute for the AR-810.
- You can scan the originals that you request to copy during printing.
- The warm-up time has been drastically shortened to approximately 160 seconds (about half of that of the Sharp copier AR-650).
- A wide variety of media from thick paper ( up to 110lb. Index) to tab paper, OHP-films, hole punched paper, etc. are acceptable.
- 'Finishing mode' and '2-sided copy', which are frequently used, put together to one display (Quick tab on the touch panel) to access easily.
- 'Automatic density mode' reads the density of originals automatically and sets the proper copy density.
- 'Automatic paper selection' reads the size of originals automatically and sets the paper size, and 'Automatic zoom selection' calculates the copy magnification.
- Comes with rich editing functions specific to digital such as '2in1/ 4in1', 'Annotation' and 'Page Numbering', etc.
- Using the reversing automatic document feeder allows you to copy at once with 'Mixed-sized original mode' though the original sizes are different.
- Loading the page memory and hard disc as standard equipment enables 2 in 1/4 in 1, 'Electronic sort' and 'Magazine sort' etc.
- When using the external LCF (optional), you can make maximum of 7500 copies continuously. (External LCF:4000 sheets, drawer: 500 sheets x 2, Tandem LCF: 2500 sheets)
- Installing an optional finisher, an optional hole punch and an optional inserter offer quick sorting such as 'Staple', 'Magazine sort' 'Hole punch' and 'Paper insert' of copies automatically.
- The optional printer controller also allows you to scan from the touch panel.

# TABLE OF CONTENTS

● Preface .....	1
Features of the AR-651/810 .....	2
● Table of contents .....	3
● Disclaimer notice .....	6
● Precautions .....	7
1. Installation .....	7
2. General precautions .....	8

<b>1. Before making copies .....</b>	<b>1-1</b>
1. Description of the digital copier and the optional equipment .....	1-2
- Main components .....	1-2
- Optional equipment .....	1-3
- Control panel .....	1-4
- Touch panel .....	1-6
2. Turning ON the power switch .....	1-8
- Turning on the power switch/Auto job start .....	1-8
- Controlling the use of the copier with account numbers .....	1-9

<b>2. How to make copies .....</b>	<b>2-1</b>
1. General copying procedures .....	2-2
2. Setting copy paper .....	2-4
- Acceptable copy paper types and sizes .....	2-4
- Handling and storing paper .....	2-5
- Changing the paper size of the drawer / Setting the drawer for special uses .....	2-6
3. Setting originals .....	2-9
- Acceptable original types and sizes .....	2-9
- When placing an original on the glass .....	2-10
- When using the reversing automatic document feeder .....	2-11
4. Auto job start (Job preset) .....	2-13
5. Interrupt copying .....	2-14
6. Stopping the copy operation .....	2-15
7. Deleting or changing order of pending jobs .....	2-17

<b>3. Setting of basic copy modes .....</b>	<b>3-1</b>
1. Paper selection .....	3-2
- Automatic paper selection (APS) .....	3-2
- Manual paper selection .....	3-3
2. Reduction and enlargement copying .....	3-4
3. Duplex copying (1-sided, 2-sided, book-type) .....	3-7
4. Copy density adjustment .....	3-11
5. Selecting original mode .....	3-13
6. Quick access mode .....	3-14

# TABLE OF CONTENTS (Cont.)

<b>4.Using the editing functions</b> .....	<b>4-1</b>
1. Image shift .....	4-2
2. Edge erase .....	4-4
3. Dual-page .....	4-5
4. X-Y zoom .....	4-7
5. Image editing .....	4-8
- Trimming/Masking .....	4-8
- Mirror image .....	4-10
- Negative/Positive reversal .....	4-11
6. 2 IN 1 / 4 IN 1 .....	4-12
7. Copying with annotation .....	4-14
8. Page numbering copying .....	4-15
9. Magazine sort (From the editing menu) .....	4-16
10. Cover copying .....	4-18
11. Sheet insertion copying .....	4-20
12. Tab paper mode .....	4-22
13. Document storage .....	4-28
14. Overlay .....	4-30
15. Sharpness adjustment .....	4-33
16. Direction of duplex images (Rotation) .....	4-34

<b>5.Using the special functions</b> .....	<b>5-1</b>
1. Continuous original feeding / Single original feeding .....	5-2
2. Mixed-sized originals .....	5-4
3. Job memory .....	5-5
4. Bypass copying .....	5-8
- Bypass copying on standard size paper .....	5-10
- Bypass copying on non-standard size paper .....	5-11
5. Weekly timer .....	5-13
6. Setting the "OTHER" size key .....	5-14
7. Setting the date and time .....	5-15
8. Setting the automatic energy save mode .....	5-16
9. Setting the automatic off-mode .....	5-17
10. Switching languages .....	5-18
11. Account number .....	5-19
12. Entering letters .....	5-28

<b>6.Selecting finishing modes (Using the optional finishers and the inserter)</b> .....	<b>6-1</b>
1. Finishing modes and finishers (optional) .....	6-2
2. Sort/group copying .....	6-3
3. Staple sorting (optional) .....	6-4
4. Magazine sort & saddle stitch mode (booklet mode)(optional) .....	6-6
5. Hole punch mode (optional) .....	6-8
6. Inserter mode (optional) .....	6-9
- Setting the inserter .....	6-10
- Using only staple and hole punch .....	6-13



<b>7. When the graphic symbols flash on the touch panel .....</b>	<b>7-1</b>
1. Description of the flashing graphic symbols .....	7-2
2. Add paper symbol .....	7-3
- Adding paper to the drawers .....	7-3
- Adding paper to the Tandem LCF (Large Capacity Feeder) .....	7-4
- Adding paper to the External LCF (Large Capacity Feeder) (optional) .....	7-5
3. Replace toner cartridge symbol .....	7-6
4. Clear paper symbol .....	7-9
① Reversing automatic document feeder .....	7-10
② Inside of the copier .....	7-12
③ Bypass guide .....	7-15
④ External LCF (optional) .....	7-15
⑤ Inserter (optional) .....	7-16
⑥ Hole punch unit (optional) .....	7-17
⑦ Finisher (optional) .....	7-18
⑧ Saddle stitch unit (optional) .....	7-19
5. Adding staples (optional) .....	7-21
6. Removing jammed staples (optional) .....	7-24
7. Disposing accumulated punched paper bits (optional) .....	7-27
8. Call service symbol/Periodic maintenance message .....	7-28

<b>8. Maintenance .....</b>	<b>8-1</b>
1. Daily inspection .....	8-2
2. Simple troubleshooting .....	8-3

<b>9. Specifications &amp; Options .....</b>	<b>9-1</b>
1. Specifications .....	9-2
2. Specifications of options .....	9-4
3. Packing list .....	9-6
4. Index .....	9-7

# DISCLAIMER NOTICE

---

The following notice sets out the exclusions and limitations of liability of SHARP Corp. (including its employees, agents and sub-contractors) to any purchaser or user ("User") of the AR-651/810, including its accessories, options and bundled software ("Product")

1. The exclusions and limitations of liability referred to in this notice shall be effective to the fullest extent permissible at law. For the avoidance of doubt, nothing in this notice shall be taken to exclude or limit SHARP CORP.'s liability for death or personal injury caused by SHARP CORP.'s negligence or SHARP CORP.'s fraudulent misrepresentation.
2. All warranties, conditions and other terms implied by law are, to the fullest extent permitted by law, excluded and no such implied warranties are given or apply in relation to the Products.
3. SHARP Corp. shall not be liable for any loss, cost, expense, claim or damage whatsoever caused by any of the following:
  - (a) use or handling of the Product otherwise than in accordance with the manuals, including but not limited to Operator's Manual, Users' Guide, and/or incorrect or careless handling or use of the Product;
  - (b) any cause which prevents the Product from operating or functioning correctly which arises from or is attributable to either acts, omissions, events or accidents beyond the reasonable control of SHARP Corp. including without limitation acts of God, war, riot, civil commotion, malicious or deliberate damage, fire, flood, or storm, natural calamity, earthquakes, abnormal voltage or other disasters;
  - (c) additions, modifications, disassembly, transportation, or repairs by any person other than service technicians authorized by SHARP Corp.; or
  - (d) use of paper, supplies or parts other than those recommended by SHARP Corp..
4. Subject to paragraph 1, SHARP Corp. shall not be liable to Customer for:
  - (a) loss of profits; loss of sales or turnover; loss of or damage to reputation; loss of production; loss of anticipated savings; loss of goodwill or business opportunities; loss of customers; loss of, or loss of use of, any software or data; loss under or in relation to any contract; or
  - (b) any special, incidental, consequential or indirect loss or damage, costs, expenses, financial loss or claims for consequential compensation;

whatsoever and howsoever caused which arise out of or in connection with the Product or the use or handling of the Product even if SHARP Corp. is advised of the possibility of such damages.

SHARP Corp. shall not be liable for any loss, cost, expense, claim or damage caused by any inability to use (including, but not limited to failure, malfunction, hang-up, virus infection or other problems) which arises from use of the Product with hardware, goods or software which SHARP Corp. has not directly or indirectly supplied.

# PRECAUTIONS

## 1. Installation

- 1** The AR-651/810 should be installed by a qualified service technician.  
**Note:** The packing material should be disposed of properly.

- 2** To obtain the best possible results, this copier should be used in conjunction with a dedicated AC power line with the following ratings.  
115V— 60Hz,20A

**Notes:**

1. The use of other appliances or other equipment on the same line as this copier may adversely affect performance and copy quality.
2. Be sure to use a 3-conductor, grounded wall outlet.
3. In areas where a 2-pin plug is used, the copier must be grounded for safety.  
Never ground it to a gas pipe, a water pipe, or any other object not suitable for grounding.

- 3** After a suitable place has been selected for installation of the AR-651/810, please do not change it. Avoid excessive heat, dust, vibration and direct sunlight. Also, provide proper ventilation as the copier emits a small amount of ozone.

**Notes:**

1. The recommended environmental range for use is as follows:
  - Temperature: 10~30°C/50~86°F
  - Humidity: 20~85% RH (Non condensing)
2. To insure optimal operation, allow clearances of at least 31.5" on the left, 31.5" on the right and 3.9" behind (refer to the illustration below).

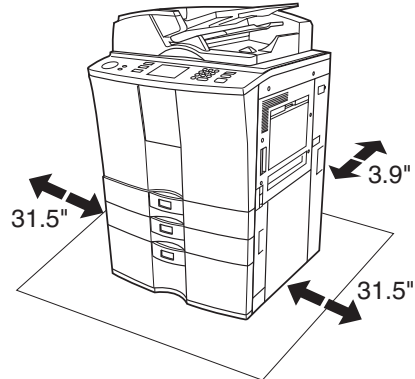

A small amount of ozone is produced within the printer during operation. The emission level is insufficient to cause any health hazard.

**Note:**

The present recommended long term exposure limit for ozone is 0.1 ppm (0.2 mg/m<sup>3</sup>) calculated as an 8 hr. time-weighted average concentration.

However, since the small amount that is emitted may have an objectionable odor, it is advisable to place the copier in a ventilated area.

**The socket outlet should be near the equipment and be easily accessible.**

# PRECAUTIONS (Cont.)

## 2. General Precautions

---

### 1 Handle and use the copier gently and carefully.

- Do not place anything on the paper drawers or the original feeding tray.
- Never allow the power cable to be trampled on or pinched between hard objects, otherwise an accident or electrical trouble might occur.
- Do not allow any metal items such as paper clips to fall into the copier.

### 2 Be sure to turn OFF the power switch (unless using the weekly timer mode):

- When you leave your office at night.
- If a power failure occurs.

**Caution: When turning OFF the power switch, be sure to do so only after the machine cycling has come to a complete stop.**

**Be sure to disconnect the power-cord plug:**

- When you do not intend to use the copier for an extended period of time.

**Be sure to turn OFF the power switch immediately and call for service:**

- If an unusual noise is heard from the copier.
- If the outside of the copier becomes unusually hot.
- If any part of this copier is damaged, or if it has been dropped.
- If the copier has been exposed to rain or liquid.

### 3 It is recommended that only supplies made or designated by Sharp be used for the AR-651/810 in order to optimize copy quality. All supplies should be stored in a cool, dry area.

For optimum performance, it is recommended that 20lb. Bond xerographic bond paper of high quality be used. Paper of lower quality may contain inherent properties such as excess paper dust and may lead to premature servicing.



#### WARNING:

1. Do not apply force or place heavy objects (8.82 lb. or more) on the original glass. Breaking the glass may cause personal injury.
2. Do not place heavy objects on the copier. They may fall and injure you.
3. Do not lean on, apply force or place heavy objects on the finisher (optional). Personal injury or property damage may result.
4. Do not place some objects or step on the external LCF (Large Capacity Feeder)(optional). They may fall and injure you.

#### "BATTERY DISPOSAL"

THIS PRODUCT CONTAINS A LITHIUM PRIMARY MEMORY BACK-UP BATTERY THAT MUST BE DISPOSED OF PROPERLY. PLEASE CONTACT YOUR LOCAL SHARP DEALER OR AUTHORIZED SERVICE REPRESENTATIVE FOR ASSISTANCE IN DISPOSING OF THIS BATTERY.

This product utilizes tin-lead solder, and a fluorescent lamp containing a small amount of mercury. Disposal of these materials may be regulated due to environmental considerations. For disposal or recycling information, please contact your local authorities or the Electronics Industries Alliance: [www.eia.org](http://www.eia.org)

### Explanatory Label

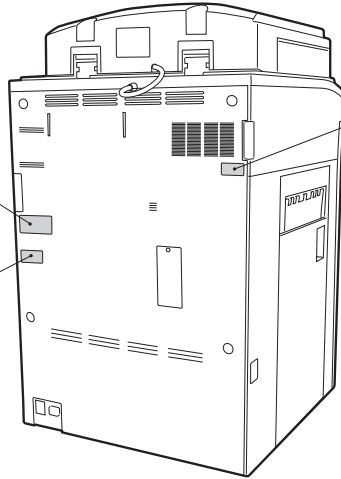

Identification Label

Certification Label

### Warning Label

DANGER - INVISIBLE LASER RADIATION WHEN OPTICAL UNIT OPEN OR DRUM UNIT REMOVED AND INTERLOCK DEFEATED. AVOID DIRECT EXPOSURE TO BEAM. >PS<

VORSICHT - UNSICHTBARE LASERSTRAHLUNG, WENN DIE ABDECKUNG GEÖFFNET ODER DIE TRÖMMELENTFERNUNG DIE VERRIEGELUNG UNWIRKSAM GEMACHT WIRD, NICHT DIREKT DEM STRAHL AUSSETZEN.

DANGER - RAYON LASER INVISIBLE LORSQUE LE BLOC OPTIQUE EST OUVERT, LE TAMBOUR RETIRE ET LE VERROUILLAGE HORS D'USAGE, EVITER L'EXPOSITION DIRECTE AU RAYON.

PELIGRO - RADIACION INVISIBLE DE LASER CUANDO LA UNIDAD OPTICA ESTA ABIERTA O LA UNIDAD DEL CILINDRO ES RETIRADA Y CUANDO EL INTERRUPTOR DE SEGURIDAD ESTA DESACTIVADO, EVITE EXPOSICION DIRECTA AL RAYO.

危険-ドラムユニットを外したり光学ユニットを開けたときドアスイッチを無効にすると不可視レーザー放射の恐れあり。ビームへの直接曝露を避けよ。

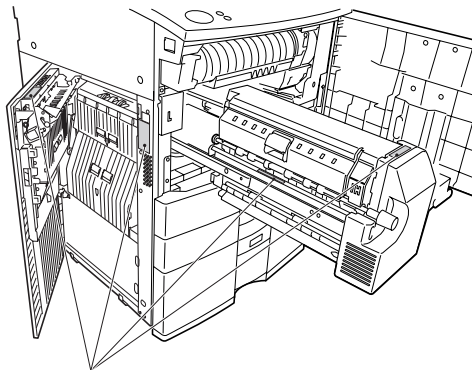
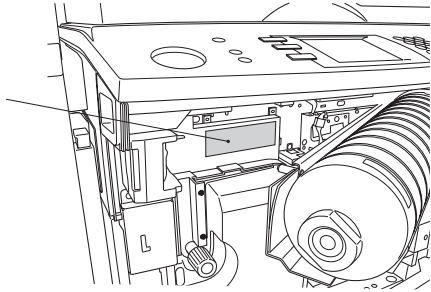
Warning for high temperature areas

# PRECAUTIONS (Cont.)

## 2. General Precautions (Cont.)

---

### ● Fixing the adjusters (stoppers)

There are four adjusters (stoppers) located in front and rear bottom (two adjusters each) of the copier. After moving/installing the copier, be sure to turn the adjusters clockwise to fix them firmly on the ground.

\*To unlock the adjusters when moving the copier, turn them counterclockwise.

If the copier is not steady, it may fall over and result in personal injury.

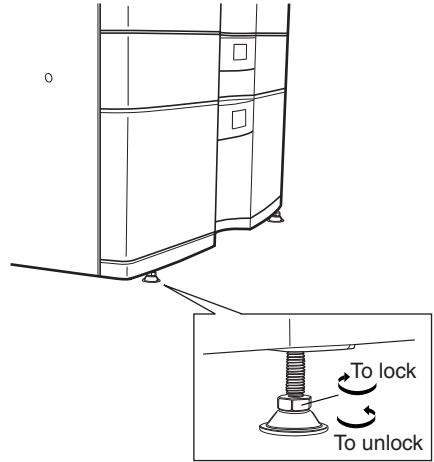

# 1. BEFORE MAKING COPIES

1. Description of the digital copier and the optional equipment .....	1-2
- Main components .....	1-2
- Optional equipment .....	1-3
- Control panel .....	1-4
- Touch panel .....	1-6
2. Turning ON the power switch .....	1-8
- Turning ON the Power Switch/Auto Job Start .....	1-8
- Controlling the use of the copier with account numbers .....	1-9

# 1. DESCRIPTION OF THE DIGITAL COPIER AND THE OPTIONAL EQUIPMENT

## Main Components

1

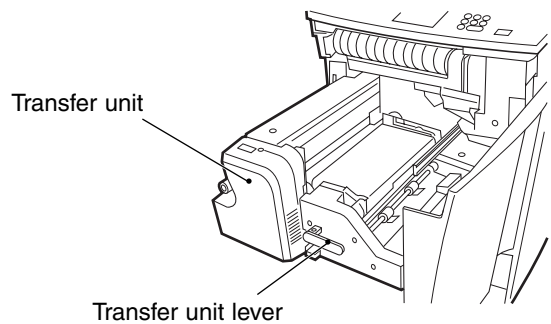
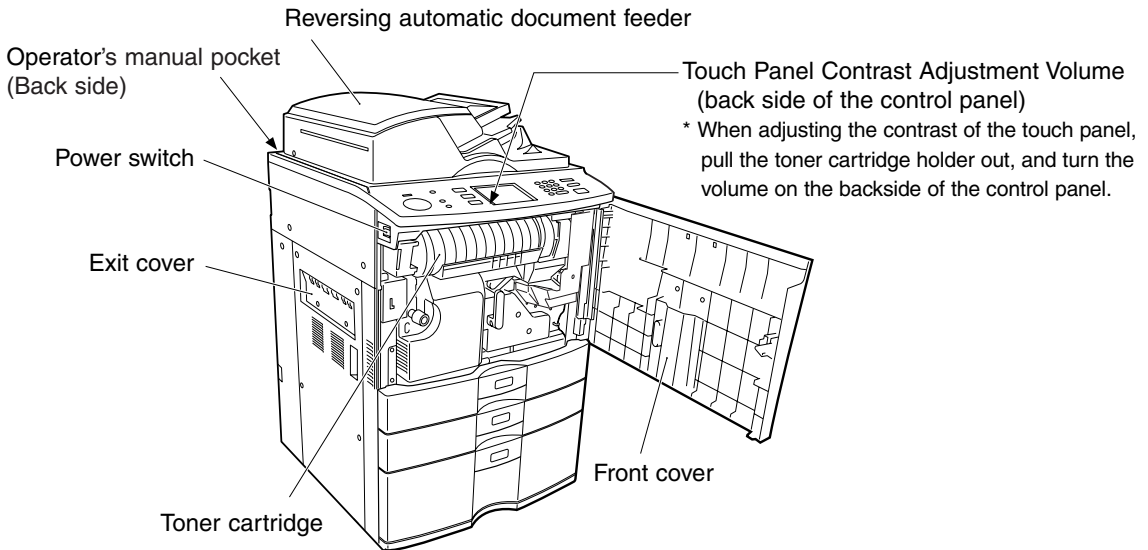
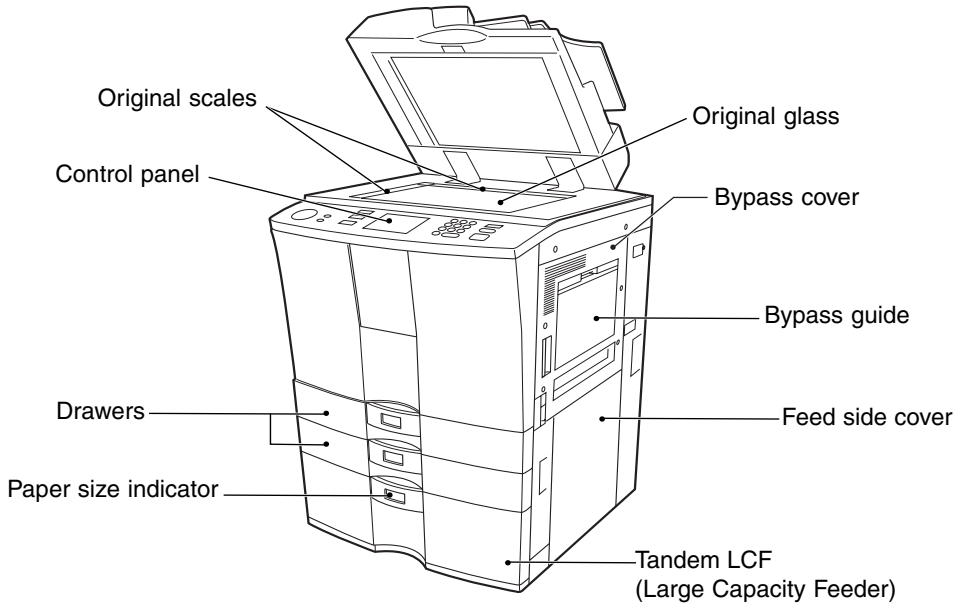



## Optional Equipment

- ① **Finisher**  
Enables the use of sort, group and staple modes, plus the hole punch (available when the optional hole punch unit is installed) and saddle stitch modes (AR-F12 only).
- ② **Hole punch unit**  
Makes punching holes on copies for binding in notebooks.
- ③ **Inserter**  
Enable the use of special types of paper and printed paper in addition to the staple sorting or the hole punch mode (Available when the optional staple sorting and the hole punch mode units are installed.) This paper is not run through fuser (heat).
- ④ **External LCF ( Large Capacity Feeder)**  
Feeds up to 4000 sheets of LT-sized paper (20lb. Bond)(recommended by Sharp) continuously.

1

### Optional Equipment Configuration

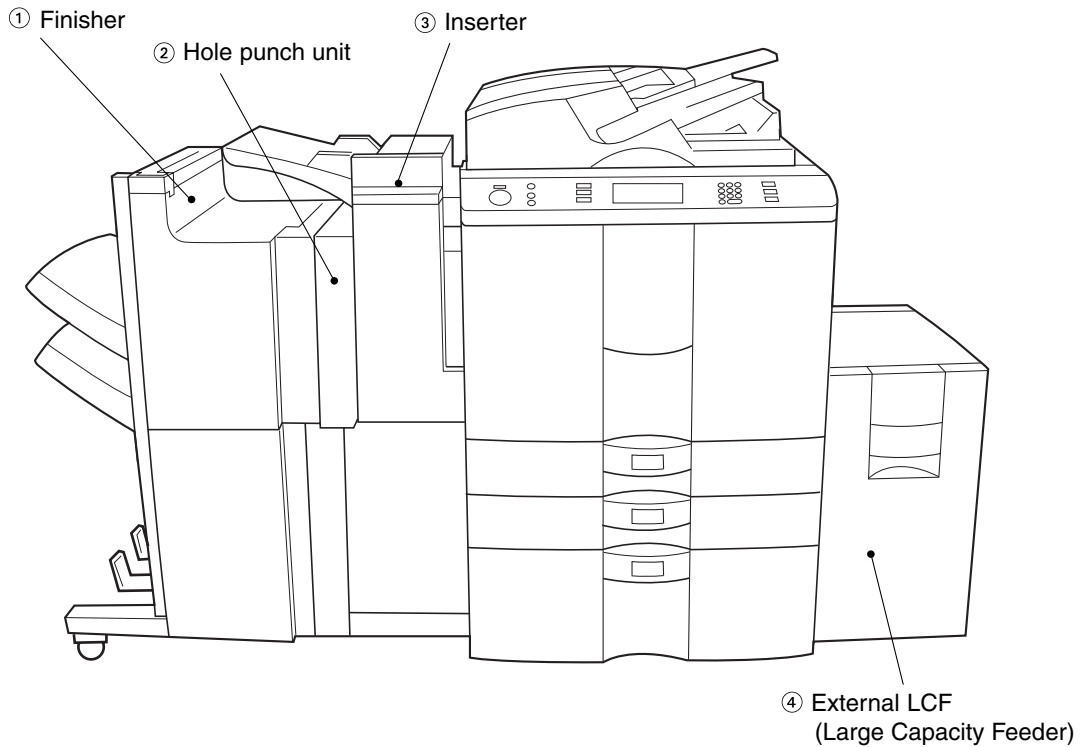

# 1. DESCRIPTION OF THE DIGITAL COPIER AND THE OPTIONAL EQUIPMENT (Cont.)

## Control Panel

1

- ① **Total Counter**  
Shows the total of copied paper since the set up of the copier.
- ② **?HELP** key  
When this key is pressed, the appropriate operation procedures are displayed.
- ③ **PRINTER/NETWORK** key  
Press this key to switch between the printer and the network (optional) functions.
- ④ **COPY** key  
Press this key to select the copy functions.
- ⑤ **JOB STATUS** key  
Press this key to monitor the statuses of 1) Job list, 2) Deleting jobs, 3) Moving jobs, 4) Copying status and 5) Setting drawers. This key flashes in case of 1) No paper in the drawers, 2) Incorrect drawer setting, 3) Full of paper in the finisher and 4) Hole punching dust bin is full
- ⑥ **Touch panel**  
Displays the copier conditions, operating procedures, and various instructions and information to the user in text and illustrations.
- ⑦ **Digital keys**  
Use these keys to enter the number of copies you want to make and so on.
- ⑧ **CCLEAR** key  
Use this key to correct numbers entered with the digital keys such as an incorrect copy quantity.

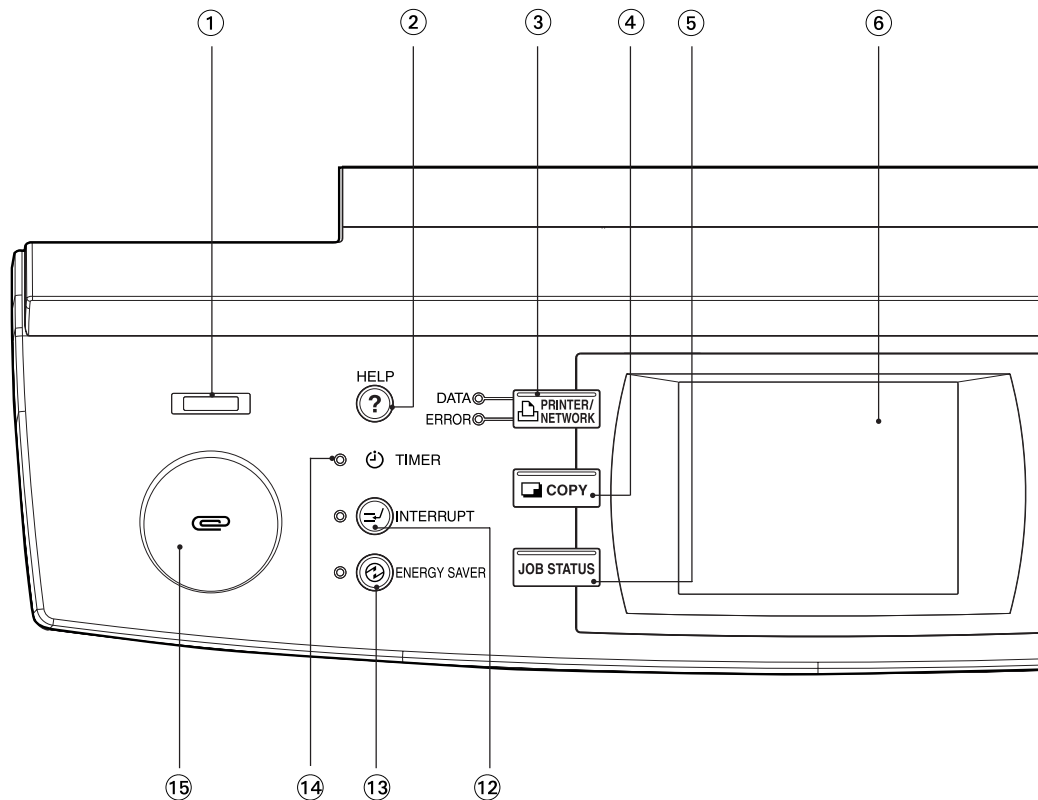

⑨ **//CLEAR ALL** key

When this key is pressed, all selected copy modes are cleared to default settings. ► Page 2-2

\* Automatic CLEAR ALL ► Right bottom of this page

⑩ **STOP** key

Use this key to stop an ongoing scan and copy operation. ► Page 2-15

⑪ **START** key

Press this key to start copying.

⑫ **INTERRUPT** key

While copying is already in progress, press this key when you want to make copies of different originals. Pressing the key again will return you to the previous copy job.

⑬ **ENERGY SAVER** key

When you are not going to use the copier for a while, press this key, which automatically turns off all display lamps. To resume copying, press this key again.

If you press this key when the optional printer controller is installed, the power supply to the printer board is not cut off, which allows automatic return of the device when it receives printer data.

⑭ **TIMER** lamp

TIMER lamp lights when the weekly timer is being used.

⑮ **Clip tray**

Put clips or staples unfastened out of originals.

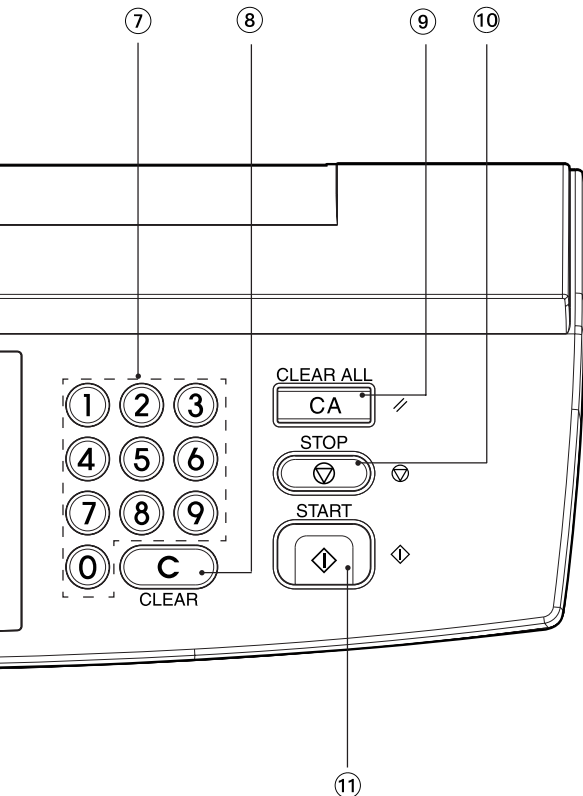

**Automatic CLEAR ALL**

Even if you do not press the //CLEAR ALL key, within the specified period of time after copying is finished or after the last key is pressed in a copy procedure, the automatic CLEAR ALL mode will work to clear all settings to defaults, and the basic screen will be displayed. While the Account Number mode is being operated, the display returns to the access code input screen. ► Page 1-9

# 1. DESCRIPTION OF THE DIGITAL COPIER AND THE OPTIONAL EQUIPMENT (Cont.)

## Touch Panel

1

When the power is turned on, and 'READY' is displayed, the following basic screen is shown on the touch panel. On the screen, currently set functions, selected functions and the copier status are shown using messages and illustrations.

\* The contents of the touch panel screens on this manual show a copier equipped with full-options.

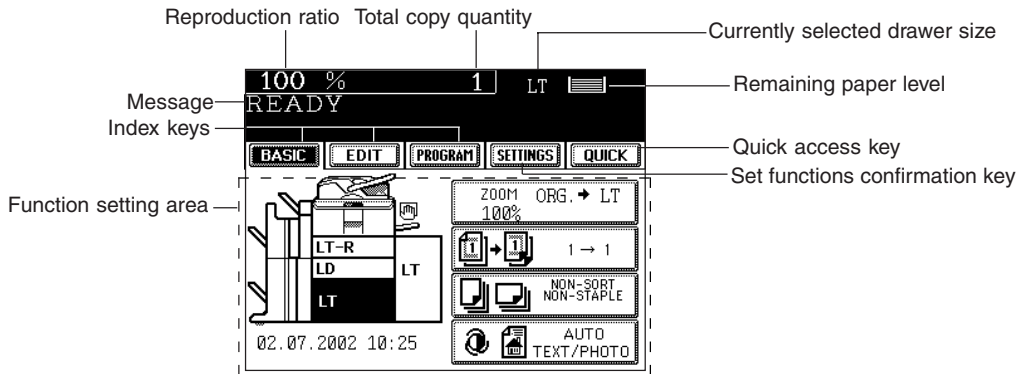

The table to show the relation between the paper size display on this machine and the actual dimensions is as follows:

Paper Size	Dimensions
LT	8-1/2" x 11"
LD	11" x 17"
LG	8-1/2" x 14"
ST-R	5-1/2" x 8-1/2"R
COMP	10-1/8" x 14"
FOLIO	8.27" x 13"
LG13	8-1/2" x 13"

### Message Display

The following information is shown on the touch panel:

Copier status, operational instructions, cautionary messages, reproduction ratios, total copy quantity, paper size of a selected drawer and amount of paper in a selected drawer.

### Touch-keys

The various function items are touch-key selectable. Press any key lightly with your finger.

#### - Index keys

Used for switching the Basic, Editing, Program menu.

#### - QUICK (Quick access) key

The finishing mode and duplex copying with high frequency of use can be set on one screen simultaneously. Also, this screen is easier to see for visually impaired persons by displaying black letters on white background.

#### - Function setting area

This is where you select or set various functions.

**SETTINGS** (set functions confirmation) key

This key allows you to confirm the functions that have been set. (The display shown on the right is an example.)

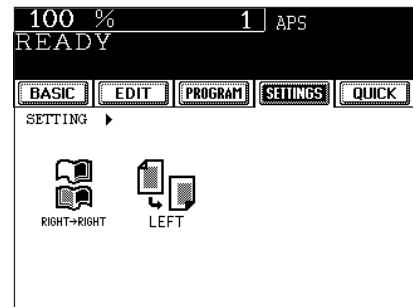

The icons displayed on the screen are as follows (some icons may not appear on the screen):

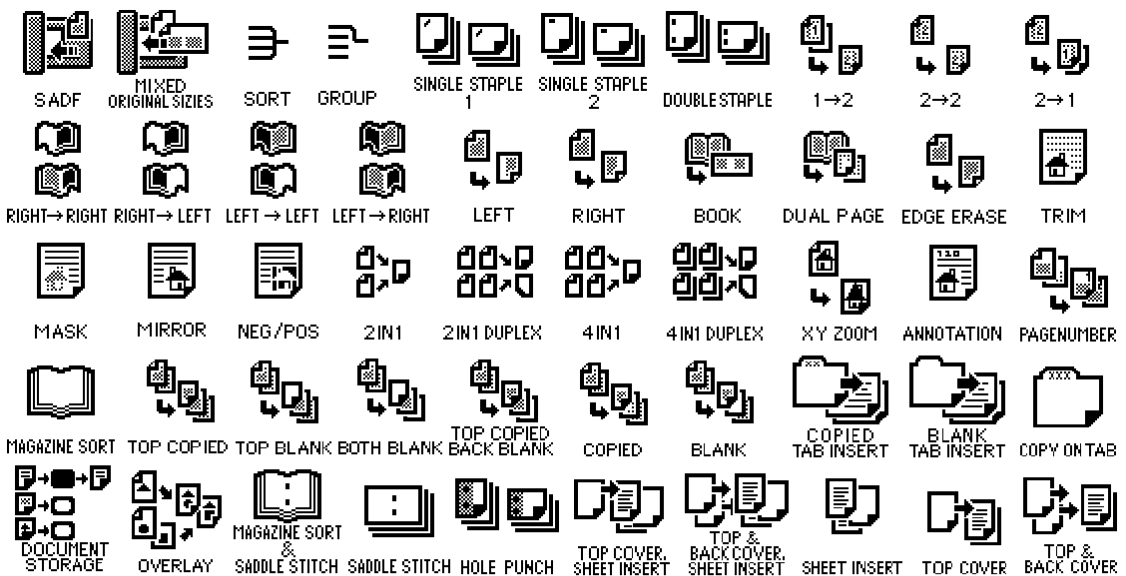

**Clearing the Functions Selected**

If you press any key that is half-tone shaded, the function selected is cleared. Also, if the copier is left inactive for approx. 45 seconds, the automatic CLEAR ALL (▶ Page 1-5) works and the settings will be cleared.

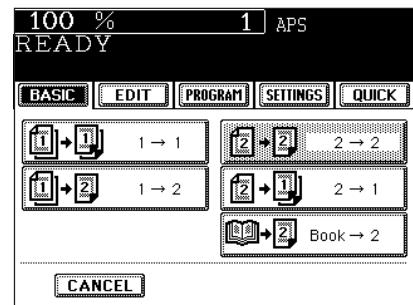

## 2. TURNING ON THE POWER SWITCH

### Turning ON the Power Switch/Auto Job Start

1

#### Turning ON the Power Switch

#### 1 Turn ON the power switch.

- This message appears on the message panel of the Basic Screen:

Wait Warming Up

- Time of warming up  
AR-651/810: Approx. 160seconds



#### 2 When "READY" appears, the copier is ready for copying.

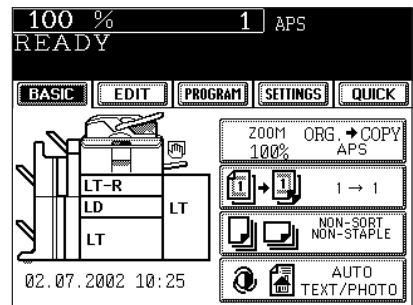

#### Auto Job Start

While the copier is warming up, place the original on the glass, select the desired copy modes and press the **START** key. The copier starts scanning the originals.

READY

When this message appears, copying will automatically start.

#### Tip

Up to 5 jobs can be stored in the memory. Place the originals for the 6th job on the original glass or the reversing automatic document feeder and press the **START** key. The following message will appear:

Auto Start

In this status, pressing the **INTERRUPT** key cancels the 6th preset job.

To clear this status, press the **CLEAR ALL** or the **STOP** key.

## Controlling the Use of the Copier with Account Numbers

With the use of account numbers, you can restrict copier users as well as manage copy volumes made by individual groups or departments of your company.

\* Registering, changing and deleting a account number ► Page 5-21

1

**1** When the account number function is in use, the screen shown on the right appears immediately after the power switch is turned on or the auto-clear is carried out.

**2** Key in a registered account number (5-digit).  
- The copier will be ready for copying.

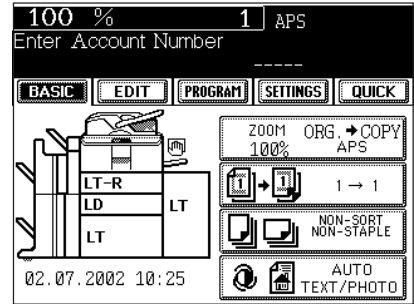

### Tip

If the following message remains displayed,

Enter Account Number

the account number you have entered may be incorrect. Key in the correct code.

### After Copying is Finished

If the account number function is in use, be sure to press the **CLEAR ALL** key on the control panel twice after finishing copying. The display returns to the account number input screen and the account number function will remain active.





# 2. HOW TO MAKE COPIES

1. General copying procedures .....	2-2
2. Setting copy paper .....	2-4
- Acceptable copy paper types and sizes .....	2-4
- Handling and sorting paper .....	2-5
- Changing the paper size of the drawer / Setting the drawer for special uses .....	2-6
3. Setting originals .....	2-9
- Acceptable original types and sizes .....	2-9
- When placing an original on the glass .....	2-10
- When using the reversing automatic document feeder .....	2-11
4. Auto job start (Job preset) .....	2-13
5. Interrupt copying .....	2-14
6. Stopping the copy operation .....	2-15
7. Deleting or changing order of pending jobs .....	2-16

# 1. GENERAL COPYING PROCEDURES

2

After placing, or confirming that there is, paper in the drawers, place the originals. When the **START** key is pressed with any settings unchanged, copies are made in the initial (default) settings \*1. You can make copies as desired by setting different copy modes.

The initial (default) settings of the copier at the time of installation are as shown below.

\*1 The copy modes that are automatically set when the power is turned on, when the energy-saving mode is cleared or when the **CLEAR ALL** key is pressed on the control panel are called the initial (default) settings.

## Initial (default) settings

Reproduction ratio. ...100%	Copy quantity .....1
Automatic paper selection	1-sided copies from 1-sided originals
Auto image density	Standard mode (original image type)
Non-sort Non-staple mode	Continuous original feed mode

## Copying Procedure

### 1 Place paper in the drawer(s). -Acceptable copy paper ▶ Page 2-4

**Tip**

When the desired paper is not placed in any of the drawers or the large capacity feeder :  
- Setting the drawer ▶ Page 2-6 - Bypass copying ▶ Page 5-8

### 2 Place the original(s).

- Acceptable originals ▶ Page 2-9 -When placing an original on the glass ▶ Page 2-10  
- When using the reversing automatic document feeder ▶ Page 2-11

### 3 Select the copy modes (① in the illustration on the page on the right).

- Use the touch panel and the digital keys.

**Tips**

- Selecting multiple copy modes may be restricted depending on their combination.  
- Copy modes cannot be changed after the **START** key is pressed (including the case when originals are divided into multiple sets when fed).

### 4 Press the **START** key (② in the illustration on the page on the right).

- When the reversing automatic document feeder is used and the continuous feed mode is selected (▶ Page 5-2), copying begins.

### 5 Place the next original (2nd side) and press the **START** key.

- Set the first page of your originals first.  
- You can also press the **YES** key before pressing the **START** key to perform the same operation.  
- Repeat this step for the subsequent originals.

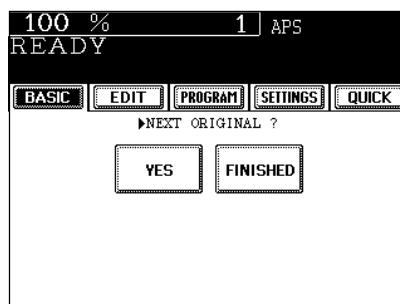

## 6 Once the final original has been scanned, press the **FINISHED** key.

- When the reversing automatic document feeder is used, and the single-feed mode is selected, the procedure is slightly different from the above. Procedure of using the single-feed mode ► Page 5-3

### Tip

- After starting copying, press the **JOB STATUS** key on the control panel, then press the **STATUS** key on the touch panel to indicate which drawer is in use. When paper runs out of each drawer, the empty drawer will flash.

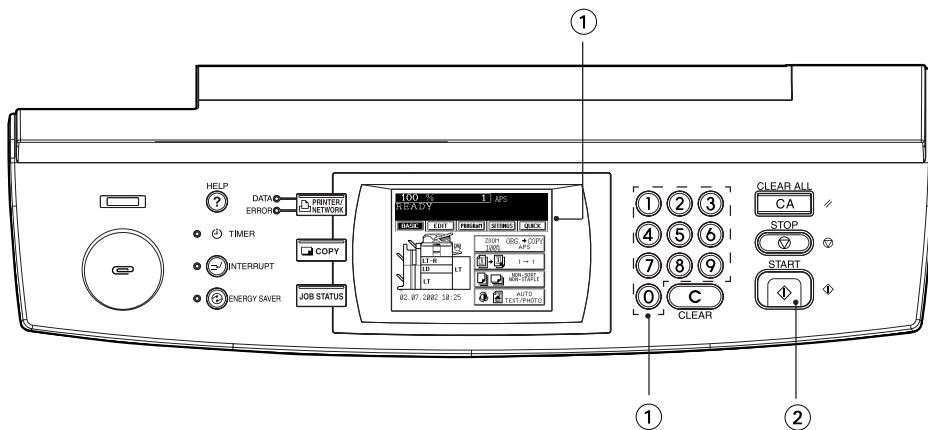

## Exiting Copy Papers

The paper exits with its printed side down except in the following cases.

- **When paper is exited with its printed side up:**
  - When 'Non-sort / Non-staple' mode is selected for setting the original on the original glass.
  - When the paper size is not set for bypass copying.

## When Coming Across the Situations below

- **To make multiple sets of copies:**
  - Key in the copy quantity.
  - To correct the input copy quantity, press the **CCLEAR** key.
- **When the paper has run out in the middle of copying:**
  - **JOB STATUS** key flashes. Press this key to check which drawer is flashing and add papers.
- **To stop a copy operation** ► Page 2-15
- **When this message appears "Wait ":**
  - The copier may automatically go into the adjustment mode. It will soon start working. Do not turn OFF the power. Just wait for a while.

## 2. SETTING COPY PAPER

### Acceptable Copy Paper Types and Sizes

For optimum copy quality, use the paper recommended by Sharp. Consult your service technician for details.

Feeder	Paper Type	Paper Size	Remarks
Drawers	Plain Paper (17- 20 lb. Bond)	(Standard size) LT format : LD, LG, LT, LT -R, ST-R, COMP (10½" x 14"), 13" LG (8½" x 13") 8.5" SQ (8½" x 8½")	500 sheets (20 lb. Bond)
	Thick 1 ( - 90 lb. Index)	A/B format : A3 (297 x 420mm), A4 (297 x 210mm), A4-R (210 x 297mm), A5-R (148 x 210mm), B4 (257 x 364mm), B5 (257 x 182mm), B5-R (182 x 257mm), FOLIO (210 x 330mm)	
	Thick 2 ( -110 lb. Index)		
	Tab paper	(Standard size) LT, A4	Only the 2nd drawer can be set *1
Tandem LCF	Plain Paper (17 - 20 lb. Bond)	(Standard size) LT	2500 sheets (20 lb. Bond)
	Thick 1 ( - 90 lb. Index)		
	Thick 2 ( - 110 lb. Index)		
External LCF (optional)	Plain Paper (17 - 20 lb. Bond)	(Standard size) LT	4000 sheets (20 lb. Bond)
	Thick 1 ( - 90 lb. Index)		
	Thick 2 ( - 110 lb. Index)		
Sheet Bypass	Plain Paper (17- 20 lb. Bond)	(Standard size) LT format: LD, LG, LT, LT -R, ST-R, COMP, 13" LG, 8.5" SQ	100 sheets (20 lb. Bond)
	Thick 1 ( - 90 lb. Index)	A/B format: A3, A4, A4-R, A5-R, B4, B5, B5-R, FOLIO	
	Thick 2 ( -110 lb. Index)	(Non-Standard size) Length: 3.9" - 12" Width: 5.8" - 18"	*1
	Tracing Paper		
	Tab paper	(Standard size) LT, A4	*1
	OHP film	(Standard size) LT, A4	*1, *2

\*1 Automatic duplex copying is not available.

\*2 Available only when non-sort non-staple mode. Staple and hole punch is not available.

- Paper between 20lb. Bond and 110lb. Index can be copied if the thick mode is used.
- The following sizes of paper can be used for hole punch: LG, LT-R (2 holes, 0.315" diameter), LD, LT, A3, A4 ( 3 holes, 0.315" diameter)
- "Maximum capacity" refers to the number of sheets when the paper recommended by Sharp is set.

## Handling and Storing Paper

---

**Pay attention to the following points:**

- Avoid using paper that is specially treated or paper that was printed on another machine, and also avoid performing double copying on the same side of paper; this may cause a malfunction.
- Do not use paper with creases, wrinkles, curled paper, paper prone to curling, smooth paper, or tough paper; this may cause paper misfeeds.
- Paper should be wrapped in its wrapping paper and stored in a damp-free place.
- To prevent paper from being folded or bent, store it evenly on a flat surface.

## 2. SETTING COPY PAPER (Cont.)

### Changing the Paper Size of the Drawer/Setting the Drawer for Special Uses

The paper size of the drawers of the copier can be changed to desired size. The drawers can also be set for cover sheet, insertion, tab paper, thick paper and special sheets.

#### Changing the Paper Size of the Drawer

2

- 1 Pull out the drawer toward you.**
  - Do not touch the slide rail of the drawer.
- 2 Push the lower part of the width guide in the direction of the arrow to remove it, and reinstall the width guide at the desired paper size (indicated on the bottom surface of the drawer).**
- 3 Push the arrow part (right side) of the size selection lever to unlock it.**
- 4 While pushing the size selection lever in the direction of the arrow, set the side guide to the desired paper width (indicated on the bottom surface of the drawer).**
  - Adjust the side guides with both hands.
- 5 Push the arrow part (left side) to lock the size selection lever.**
- 6 Place paper in the drawer(s).**
  - Place the paper in face down.
  - Notes for placing paper in the drawer. ► Page 7-3, step 2
- 7 Push the drawer straight into the copier until it comes to a stop.**
  - Be sure to push the drawer carefully and fully in.

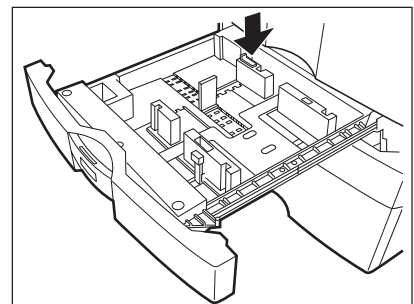
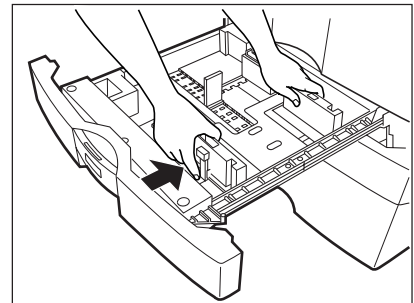
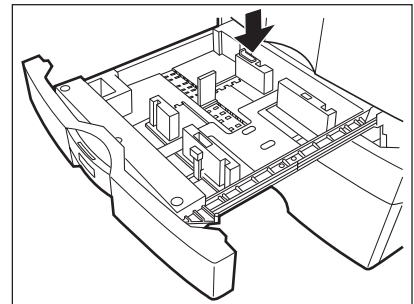
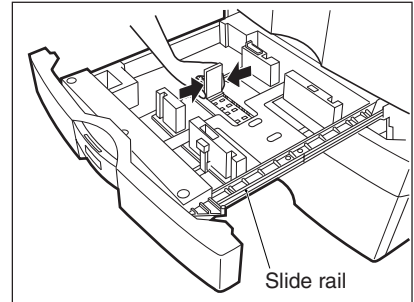

#### Tip

Be careful not to let your fingers be caught when closing the drawer.

- 8** Press the **JOB STATUS** key on the control panel, then the **CASSETTE** key on the touch panel.

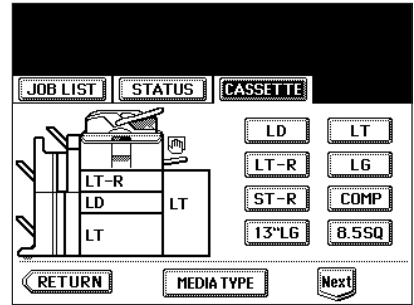

- 9** Press the drawer key corresponding to that in which the paper size has been changed, then press the key of the paper size newly set.

- Chinese paper sizes (16K, 8K and 16K-R) can be selected on the screen which appears when the **Next** key is pressed once. Pressing the **Next** key again will display the AB format paper sizes.
- Press the **RETURN** key on the touch panel or the **JOB STATUS** key on the control panel to return to the basic screen.

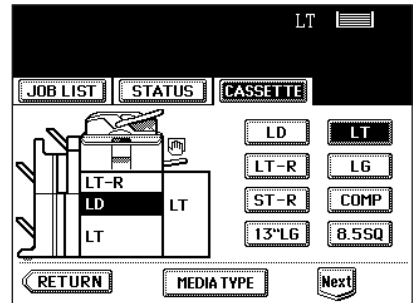

### Setting the Drawer for Special Uses

You can set the drawer for various uses (cover sheet, sheet insertion and tab paper, thick paper special sheets). The default paper is plain paper ► Page 2-4

- Drawer for cover sheet ► Page 4-18
- Drawer for sheet insertion ► Page 4-20
- Drawer for tab paper (must be used in second drawer) ► Page 4-22
- Drawer for special sheets...Colored paper, paper with a watermark, etc.

- 1** Place paper in the drawer(s).

- Place the paper with its face down.
- Setting tab paper ► Page 4-22
- For changing the paper size in the drawer, follow step 1 to 9 on the previous page.

- 2** Press the **JOB STATUS** key on the control panel, then the **CASSETTE** key on the touch panel. After this procedure, press the **MEDIA TYPE** key.

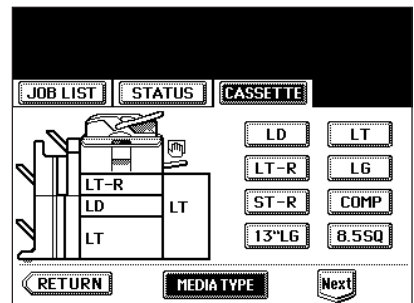

## 2. SETTING COPY PAPER (Cont.)

### Changing the Paper Size of the Drawer/Setting the Drawer for Special Uses(Cont.)

**3** Press the drawer key corresponding to that in which the paper has been set, then press the key of the paper type newly set.

- If you want to select the **COVER**, **INSERT**, or **TAB**, make sure that paper with the same size as that for the **COVER**, **INSERT**, or **TAB** PAPER is set in the other drawer including the optional external LCF (Large Capacity Feeder).

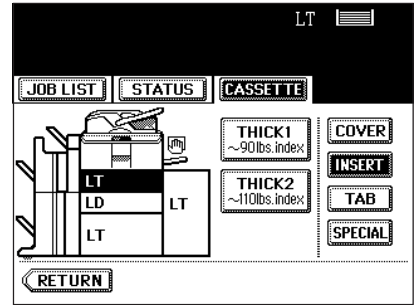

#### Tip

Press **THICK 1** or **THICK 2** depending on the paper weight of cover sheet, insertion, tab paper and special sheet.

In that case, '×<sub>1</sub>' or '×<sub>2</sub>' is displayed in the drawer key.

\* For example, when inserting 90lb. Index paper, press

**INSERT** key, and press **THICK 1** key.

- The setting is completed as shown on the right.

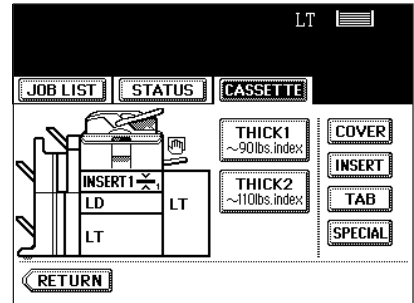

#### Tip

Up to 2 drawers can be set for the sheet insertion.

After having set **INSERT 1**, press the drawer key corresponding to that in which the paper for **INSERT 2** has been set, and press the **INSERT** key.

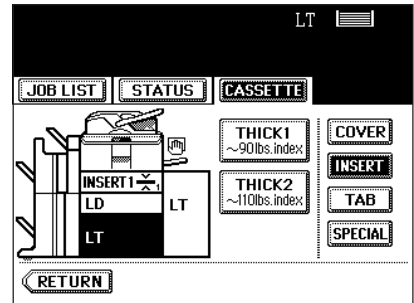

### Clearing the Drawer for Special Uses

Press the drawer key corresponding to that which is set for the special use, then press the key of the same mode as the drawer.

- If you clear **INSERT 1** when both **INSERT 1** and **INSERT 2** are set, the drawer for **INSERT 2** changes to **INSERT 1**.
- Replace the paper set in the drawer as required.
- Press the **RETURN** key on the touch panel or the **JOB STATUS** key on the control panel to return to the machine to the basic screen (before **JOB STATUS** key is pressed on the step 2).

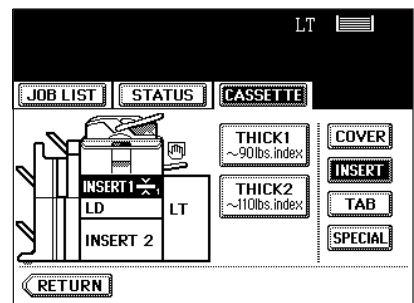





## 3. SETTING ORIGINALS (Cont.)

### When Placing an Original on the Glass

#### Sheet Originals

When using the non sorting and non staple mode, the paper exits face up.

2

- 1** Raising the reversing automatic document feeder, place the original face down on the glass.
- 2** Align the original against the left inner corner of the glass.
- 3** Lower the reversing automatic document feeder slowly.

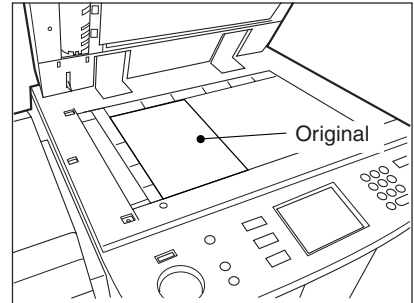

- When copying originals with high transparency, such as OHP films and tracing paper, place a blank sheet of paper the size of the original or larger over the original.

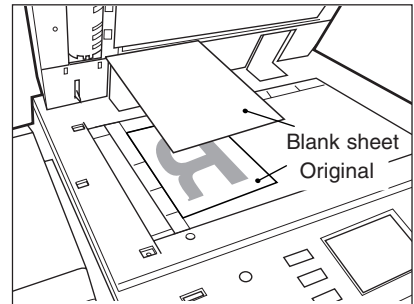

#### Book-type Originals

- 1** Raising the reversing automatic document feeder, place the original in the direction as shown in the illustration.

- When using the Book-Type Originals ▶ 2-sided Copies (▶ Page 3-8) or the Dual-Page (▶ Page 4-5) function, center the book original on the yellow indicator line.

- 2** Lower the reversing automatic document feeder slowly.

- Do not try to force the reversing automatic document feeder to fully close over a very thick original, such as a big book. Copies can be made even if the cover or feeder does not close fully.
- During copying, an intense light may leak out. Do not look at the original glass surface.

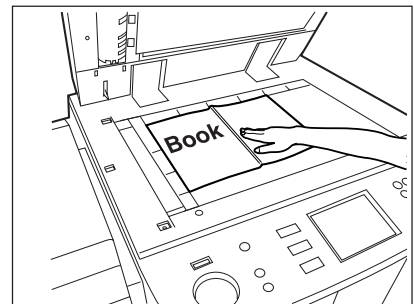

# When Using the Reversing Automatic Document Feeder

## Precautions for Using the Reversing Automatic Document Feeder

Do not use the following types of originals as they tend to misfeed or become damaged:

- (1) Badly wrinkled or folded originals; in particular, originals whose leading edge is curled may fail to be correctly fed.



- (2) Originals with carbon paper



- (3) Taped, pasted or clipped (cut out) originals

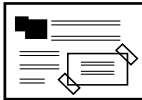

- (4) Clipped or stapled originals



- (5) Originals with holes or torn originals



- (6) Damp originals

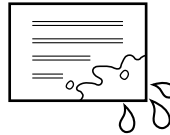

- (7) OHP film originals

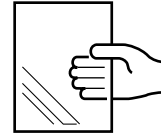

\*Do not use tracing paper, permeable paper and coating paper (coated with wax, etc).

Also, the following originals should be handled carefully:

- (1) Folded or curled originals should be smoothed out before being used.

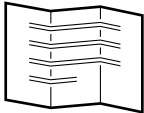

- (2) Originals, two of which, when pinched between two fingers, cannot be moved, or originals which are surface-treated may fail to be separated properly.

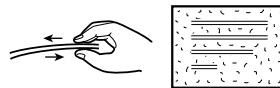

\*The different sized originals are limited for setting. ▶ Page 5-4

**Tip**

If the scanning area and guide area are dirty, it may cause black streaks, etc. on the printed paper. Cleaning them preferably once a week is recommended. ▶ Page 8-2

## Exiting Originals

Originals in progress automatically exit on ① or ② depending upon the size of originals.

①..... LT, ST-R, A4, A5-R, B5

②..... LD, LG, LT-R, COMP, A3, A4-R, B4, B5-R, FOLIO

**Tip**

When the papers exit on ②, pull up the stopper to prevent originals from falling.

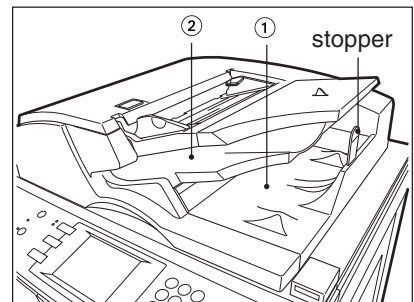

### 3. SETTING ORIGINALS (Cont.)

#### When Using the Reversing Automatic Document Feeder (Cont.)

In the Continuous Feed Mode ► Page 5-2

- Be sure to set only originals with the same size. Mixed-sized originals ► Page 5-4

2

#### 1 After aligning the edges of originals well, place them face up and align the slides to the width of the originals.

- Align the originals in the order from the top because they will be fed from the top.
- One original sheet is also acceptable.
- Maximum number of sheets (all sizes) can be set in the reversing automatic document feeder: 100 sheets (20lb. Bond) or less than 0.62" in height.

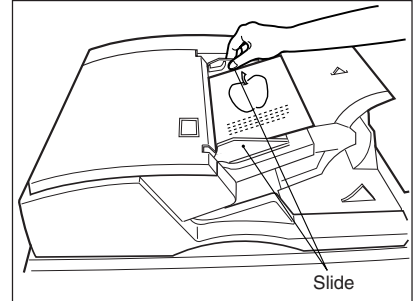

#### Tip

When the number of originals is too large to be set at one time, you can divide the originals into two to ten sets and set them one after another. To do so, place the first set of originals first, and press the **(CONTINUE)** key while the scanning is in progress. After they have been scanned, place the previous set of originals.

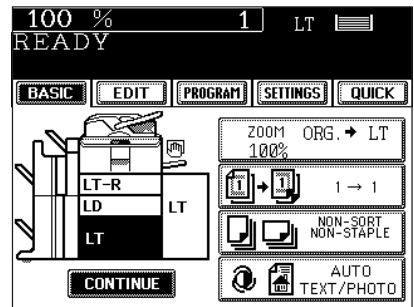

In the Single-feed Mode ► Page 5-3

#### 1 Align the slides to the desired original size.

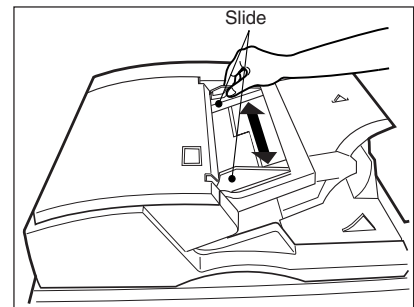

#### 2 Insert the original face up and straight along the slides; it will then be pulled in automatically.

- When the original starts being pulled in, let go of it.

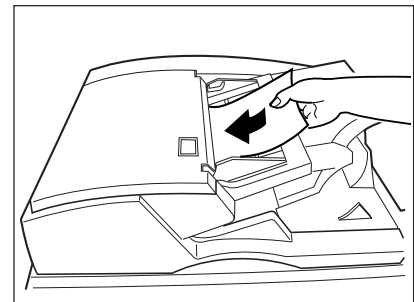

# 4. AUTO JOB START (JOB PRESET)

While multi-copying is in process, you can reserve the next copy.

## 1 Place the original(s). ▶ Page 2-9

- Select copy modes as required.

## 2 Press the **START** key.

- Up to 5 jobs including the current printing job can be stored in the memory. Place the originals of the 6th job on the original glass or the reversing automatic document feeder and press the **START** key. The following message will appear:

Auto Start

### Confirming and Cancelling Auto Job Start

#### ● Confirming auto job start

Press the **JOB STATUS** key on the control panel, then the **JOB LIST** key on the touch panel.

User Name	Time	Paper	Pages	Sets
COPY	23:16	LD	1	1
COPY	23:16	LT	2	2
COPY	23:16	LT-R	3	3
COPY	23:16	LG	4	4

DELETED 1/1

#### ● Cancelling the job while waiting for the original to be stored in the memory.

If you want to cancel copying the original when it has already been set on the glass or the reversing automatic document feeder and the following message is displayed:

Auto Start

press the **CLEAR ALL** or the **STOP** key.

#### ● Cancelling the job while waiting for the original to be copied.

Deleting the data waiting to be printed (except for the case above)

▶ Page 2-15

# 5. INTERRUPT COPYING

While multicopying is in progress, you can interrupt it and make copies from different originals.

\* The following modes cannot be used with interrupt copying.

- Cover sheet copying - Sheet insertion copying - Document storage - Overlay

2

## 1 Press the **≡/INTERRUPT** key.

- This message appears:

Job interrupted job 1 saved

- Interrupt copying is available while copying is in progress.

### Tip

Auto Start

When the above message is displayed, pressing the **≡/INTERRUPT** key cancels the job of auto start (the 6th job).

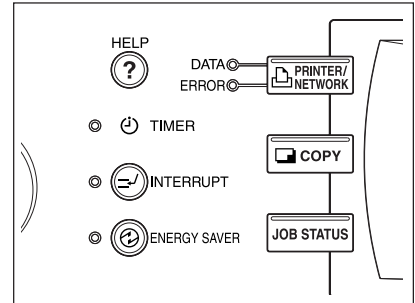

## 2 Replace the original with a new one. ► Page 2-9

● Select other copy modes as required.

## 3 Press the **◇START** key.

## 4 After you have finished interrupt copying, press the **≡/INTERRUPT** key again.

- The following message appears:

READY to resume job 1

### Tip

Without performing step 4, the interrupt copying mode will automatically be cancelled and the previously interrupted copy job will resume in a certain period of time after the interrupt copying has finished.

## 6. STOPPING THE COPY OPERATION

If you want to stop the operation during scanning or multicopying, use the **STOP** key.

### Stopping the Scanning of the Original

- 1 Press the control panel **STOP** key on the operational panel during the scanning.

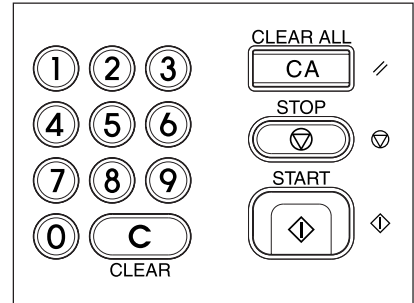

- 2 If the screen on the right appears, press the **MEMORY CLEAR** key.

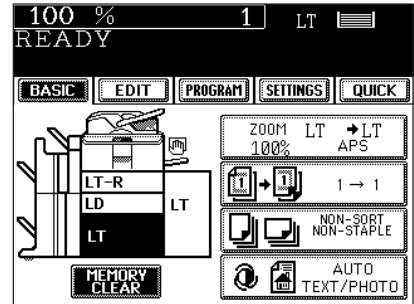

### Stopping a Multicopying Operation

- 1 Press the **STOP** key on the operational panel during the multicopying operation.
- 2 Press the **Delete** key.
- 3 The data will be deleted and the multicopying operation will stop.
  - If there is other data waiting to be printed, will start being output.

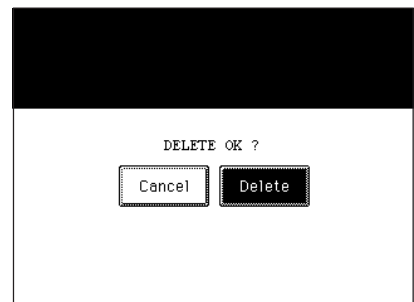

# 7. DELETING OR CHANGING ORDER OF PENDING JOBS

If data is waiting to be printed, you can delete them, or change the printing order.

## Deleting the Job

2

In the following procedure, you can delete the multicopying operation as well.

- 1 Press the **JOB STATUS** key on the control panel, then the **JOB LIST** key on the touch panel.

**Tip**

The menu on the right shows an example of the queue.

User Name	Time	Paper	Pages	Sets
COPY	23:16	LD	1	1
User B	23:16	LT	2	2
COPY	23:16	LT-R	3	3
COPY	23:16	LG	4	4

- 2 Select the job you want to delete, then press the **DELETE** key.

User Name	Time	Paper	Pages	Sets
COPY	23:16	LD	1	1
User B	23:16	LT	2	2
COPY	23:16	LT-R	3	3
COPY	23:16	LG	4	4

- 3 Press the **Delete** key.



- 4 The job will be deleted.

**Tip**

Press the **JOB STATUS** key on the control panel to return the basic screen (before **JOB STATUS** key is pressed on the step 1). If there is no job waiting to be printed, you can also return to the basic screen by pressing the **RETURN** key on the touch panel.

User Name	Time	Paper	Pages	Sets
COPY	23:16	LD	1	1
User B	23:16	LT	2	2
COPY	23:16	LG	4	4



## Changing the Printing Order

- 1 Press the **JOB STATUS** key on the control panel, then the **JOB LIST** key on the touch panel.

Printing 1 LD

Press [JOB STATUS] to return

[JOB LIST] [STATUS] [CASSETTE]

User Name	Time	Paper	Pages	Sets
COPY	23:16	LD	1	1
User B	23:16	LT	2	2
COPY	23:16	LT-R	3	3
COPY	23:16	LG	4	4

[DELETE] 1/ 1

- 2 Select the job you want to move.

Printing 1 LD

Press [JOB STATUS] to return

[JOB LIST] [STATUS] [CASSETTE]

User Name	Time	Paper	Pages	Sets
COPY	23:16	LD	1	1
User B	23:16	LT	2	2
COPY	23:16	LT-R	3	3
COPY	23:16	LG	4	4

[DELETE] [MOVE] 1/ 1

- 3 Press the **MOVE** key, then press the position where the selected job is to move to.

- The job to be moved will be shifted next to new priority.
- The job with top priority (having been printed or suspended) cannot be moved.

Printing 1 LD

Press [JOB STATUS] to return

[JOB LIST] [STATUS] [CASSETTE]

User Name	Time	Paper	Pages	Sets
COPY	23:16	LD	1	1
User B	23:16	LT	2	2
COPY	23:16	LT-R	3	3
COPY	23:16	LG	4	4

[MOVE] 1/ 1

- 4 The changing order is completed.

- If you want to return to the basic screen (before **JOB STATUS** key is pressed): ► Page 2-16, Tip

Printing 1 LD

Press [JOB STATUS] to return

[JOB LIST] [STATUS] [CASSETTE]

User Name	Time	Paper	Pages	Sets
COPY	23:16	LD	1	1
COPY	23:16	LT-R	3	3
User B	23:16	LT	2	2
COPY	23:16	LG	4	4

[DELETE] 1/ 1



# 3. SETTING OF BASIC COPY MODES

1. Paper selection .....	3-2
- Automatic paper selection (APS) .....	3-2
- Manual paper selection .....	3-3
2. Reduction and enlargement copying .....	3-4
3. Duplex copying (1-sided, 2-sided, book-type) .....	3-7
4. Copy density adjustment .....	3-11
5. Selecting original mode .....	3-13
6. Quick access menu .....	3-14

# 1. PAPER SELECTION

## Automatic Paper Selection (APS)

When you place regular-sized originals on the glass or in the reversing automatic document feeder, the built-in sensors automatically work to detect the size of the originals, helping the copier select and copy on paper that is the same size as the original.

- \* Depending on the condition of the original, automatic paper selection may not work correctly. In that case, select the paper size manually. ► Page 3-3
- \* This mode can only be used for actual-size (100%) copying.
- \* Original sizes capable of automatic detection ► Page 2-9

- 1** Place paper in the drawer(s). ► Page 2-4
- 2** Place the original(s). ► Page 2-9
- 3** Confirm that the Automatic Paper Selection mode (default setting) is selected on the basic screen.

- If the Automatic Paper Selection mode is not selected, press the (ZOOM...) key, then press the (APS) key on the next screen.
- If the following messages are shown, proceed as directed:

Change direction of original

Set correct drawer

### Tip

When the selected drawer size and the original size are the same, the copier rotates the original data 90° and makes a copy in the same size as the original even if those directions differ (e.g. a LT-size original is set while the same size paper is set in R direction). This function, however, is applicable to plain paper only.

- Select other copy modes as required.

- 4** Press the (START) key.

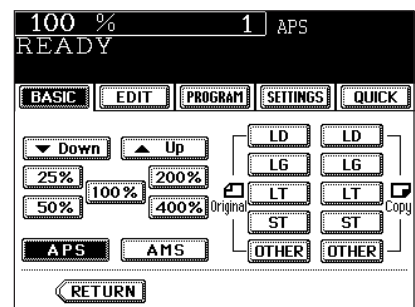
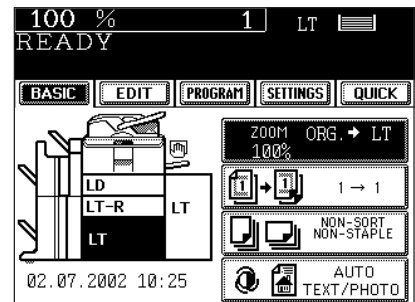
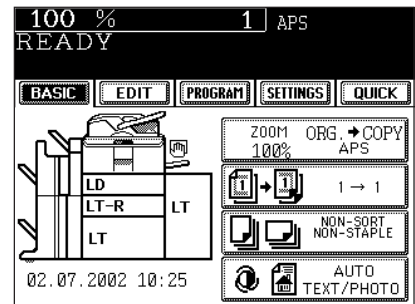

## Manual Paper Selection

It may not be possible for the device to perform Automatic Paper Selection with highly transparent originals such as OHP films and tracing paper, wholly dark originals or originals with dark borders, or irregular sized originals such as newspapers and magazines. For these types of originals, use manual paper selection.

\* When the desired size of paper is not set in any of the drawers, you can change the paper size of the drawer (► Page 2-6) or use the sheet bypass copying (► Page 5-8).

- 1 Place paper in the drawer(s).** ► Page 2-4
  - When using this mode in bypass copying, be sure to specify the paper size. ► Page 5-10, 5-11
- 2 Place the original(s).** ► Page 2-9
- 3 On the basic screen, press the drawer icon representing the desired paper size.**

- Or press the **ZOOM...** key to enter the next screen, and press the key of the desired paper size.
- **OTHER** key ► Page 5-14

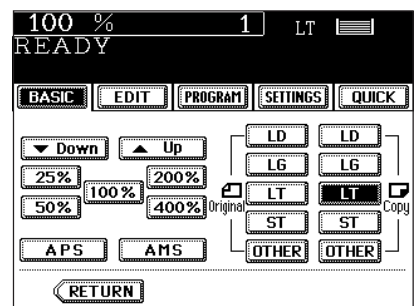
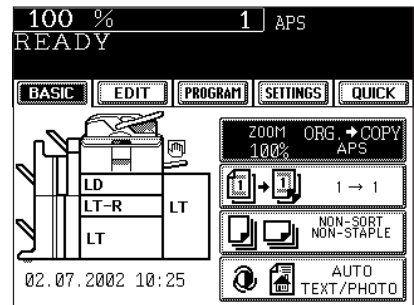
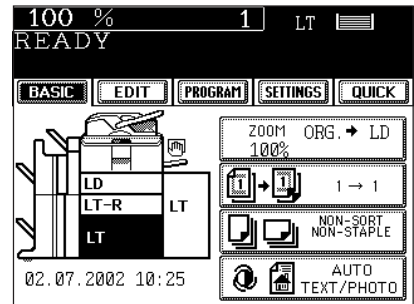

- Select other copy modes as required.

- 4 Press the **START** key.**

## 2. REDUCTION AND ENLARGEMENT COPYING

When placing originals on the glass, you can copy them at the reducing and enlarging rate of 25 to 400%. For the reversing automatic document feeder, you can make the copy at the reducing and enlarging rate of 25 to 200%.

There are the following three ways of making copies in the reduction and enlargement mode:

- ① Using Automatic Magnification Selection (AMS)
- ② Specifying both original size and copy size
- ③ Using the reduction/enlargement zoom keys or the one-touch zoom keys

\* It is not possible for the device to perform Automatic Magnification Selection with highly transparent originals such as OHP films and tracing paper, wholly dark originals or originals with dark borders, or irregular sized originals such as newspapers and magazines. For these types of originals, use the other reduction/enlargement modes.

Original sizes for which Automatic Magnification Selection (automatic detection) is available ► Page 2-9

\* Set the paper size for "the OTHER" key as required (► Page 5-14). When the set originals or paper are a non-standard size other than LD, LG, LT or ST you will select the (OTHER) key on the screen of step 3 below. Before pressing it, you need to make the (OTHER) key recognize the same size as the originals or paper that have been set.

3

### ① Automatic Magnification Selection (AMS)

**1** Place paper in the drawer(s). ► Page 2-4

**2** Press the desired drawer, then the (ZOOM...) key.  
- The copy paper size is selectable on the screen in step 3 as well.

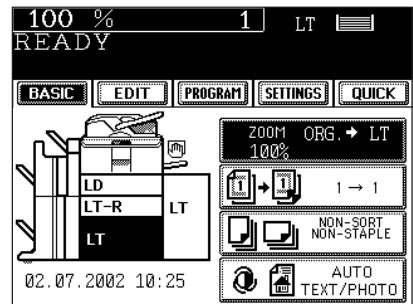

**3** Press the (AMS) key.  
- (OTHER) key ► Page 5-14

**4** Place the original(s). ► Page 2-9  
- The built-in sensors automatically detect the size of the original(s) and compute the reproduction ratio using the specified paper size.  
- If the following messages are shown, proceed as directed:

Change direction of original

Use reduced-size cassette

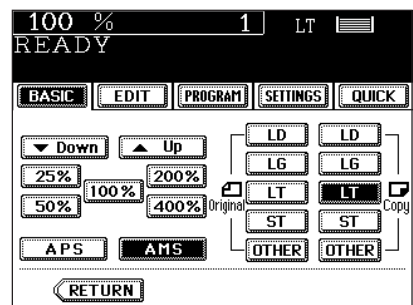

- Select other copy modes as required.

**5** Press the (START) key.

## ② Specifying both Original Size and Copy Size

- 1 Place paper in the drawer(s). ► Page 2-4
- 2 Place the original(s). ► Page 2-9
- 3 Press the desired drawer, then the **ZOOM...** key.
  - The copy paper size is selectable on the screen in step 4 as well.

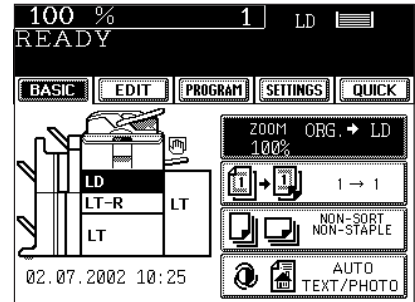

- 4 Press the **ORIGINAL SIZE** key of the same size as the original.
  - Using the original size and copy size, the correct reproduction ratio is computed and displayed on the screen.
  - **OTHER** key ► Page 5-14

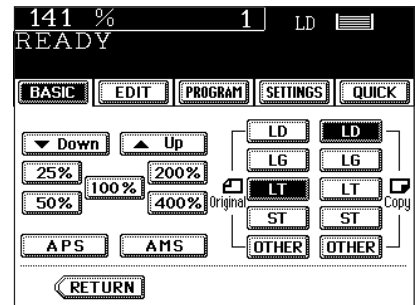

- Select other copy modes as required.

- 5 Press the **START** key.

## 2. REDUCTION AND ENLARGEMENT COPYING (Cont.)

### ③ Using the Reduction / Enlargement Zoom Keys or One-touch Zoom Keys

**1** Place paper in the drawer(s). ► Page 2-4

**2** Place the original(s). ► Page 2-9

**3**

**3** Press the drawer icon representing the desired copy paper size, then press the **(ZOOM....)** key.

- The copy paper size is selectable on the screen in step 4 as well.

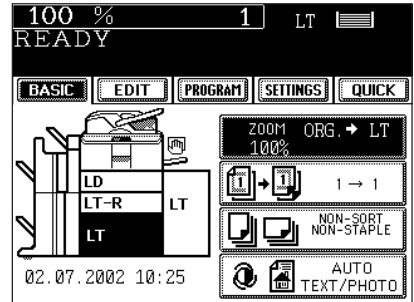

**4** Press the **(▲ UP)** (or **(▼ DOWN)**) key to set the desired reproduction ratio.

- Each time you press either key, the reproduction ratio changes by 1%. Holding down the key changes it continuously.
- You can also select the reproduction ratio by pressing the **(400%)**, **(200%)**, **(100%)**, **(50%)** or **(25%)** key directly. (When placing the originals on the reversing automatic document feeder, you cannot select **(400%)** key.)
- **(OTHER)** key ► Page 5-14

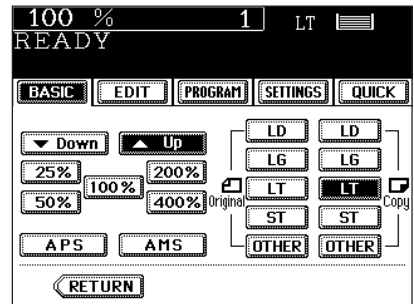

- Select other copy modes as required.

**5** Press the **(◀START)** key.



### 3. DUPLEX COPYING (1-SIDED, 2-SIDED, BOOK-TYPE)

This function allows you to set the type of originals (1-sided, 2-sided or book-type) and the desired type of copying (1-sided or 2-sided).

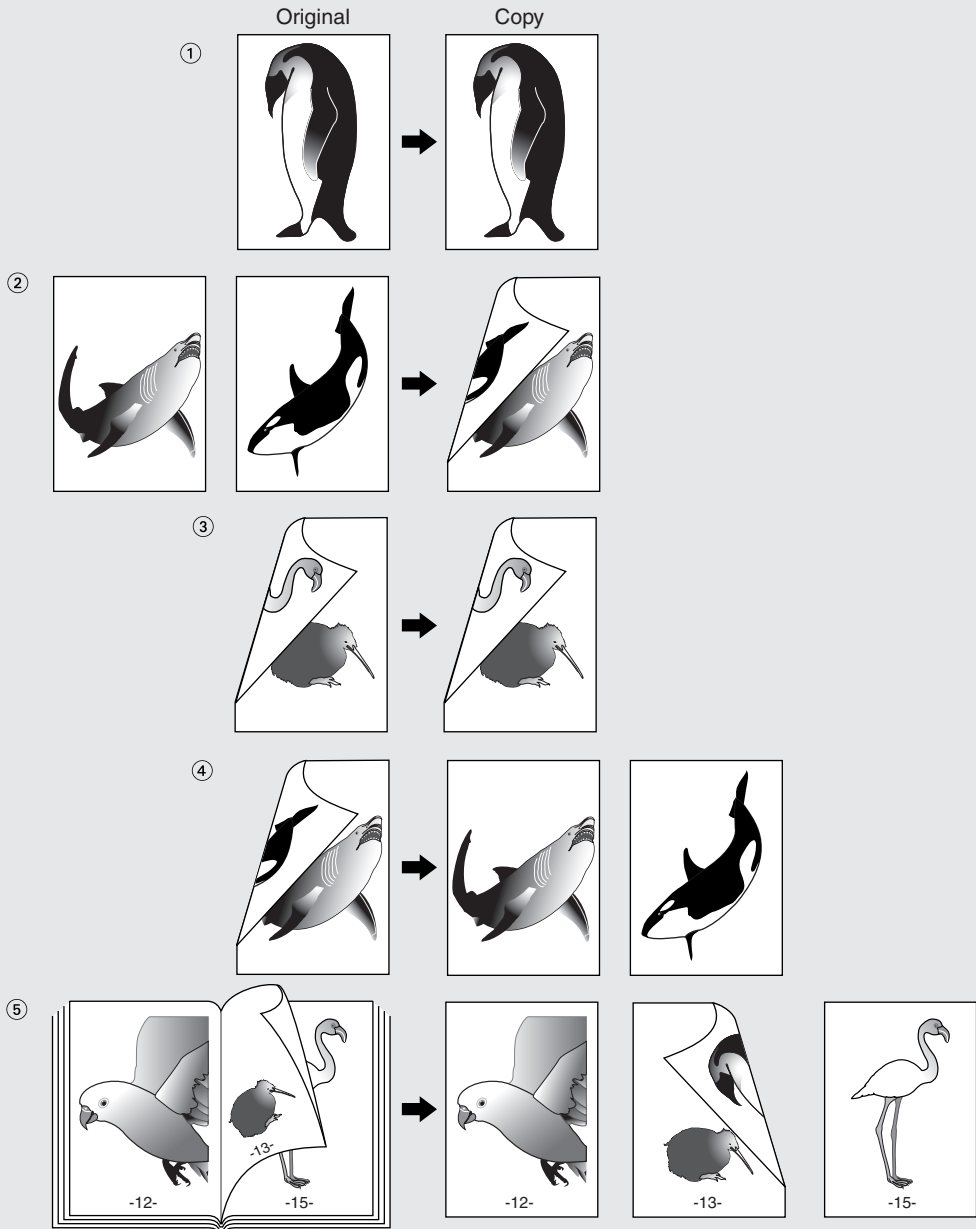

\* ② ③ ⑤ can not be used by OHP film.

## 3. DUPLEX COPYING (1-SIDED, 2-SIDED, BOOK-TYPE) (Cont.)

- 1 Place paper in the drawer(s).** ▶ Page 2-4
  - When using the mode of 1-Sided Originals to 2-Sided Copies and 2-Sided Originals to 2-Sided Copies in bypass copying, be sure to specify the paper size. ▶ Page 5-10,5-11

- 2 Place the original(s).** ▶ Page 2-9

3

- 3 Press the key (shaded) on the right basic screen.**
  - The default setting is 1-Sided Originals to 1-Sided Copies.

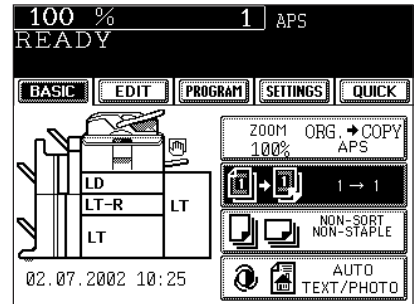

- 4 Press the key as required.**
  - When using the mode of Book-Type Originals to 2-Sided Copies, follow the procedure below.

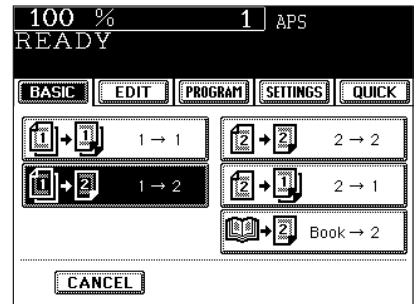

- Select other copy modes as required.

- 5 Press the **START** key.**
  - When placing originals on the glass, perform from steps 5 on page 2-2 to step 6 on page 2-3 continuously.

### Book-Type Originals ▶ 2-Sided Copies

\*The acceptable paper sizes for this function are LT only.

- 1 Follow the same procedure 1 to 3 as shown above.**

**2** Press the **BOOK→2** key.

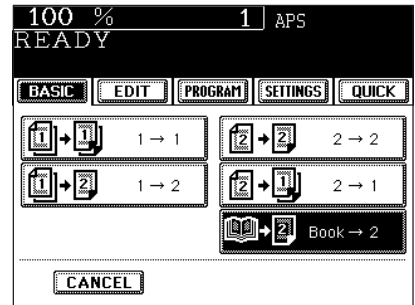

**3** Select the book copying type.

- Press the **RIGHT→RIGHT** key if copying should start at a right-hand page and end at a right-hand page. By the same token, you can choose from among the **RIGHT→LEFT**, **LEFT→LEFT** and **LEFT→RIGHT** keys.

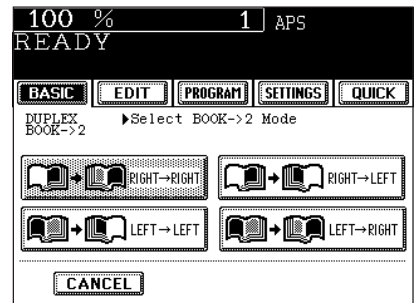

**4** Select LT copy size.

**5** If you need a binding space, select the book margin mode from the Image Shift function (► Page 4-2).

- Select other copy modes as required.

**6** Place the first page(s) to be copied on the glass, and press the **START** key.

- If you do not copy your originals from the first page, the copies will not be arranged in the same order as the original.
- Center the book on the yellow indicator line with its bottom toward you.

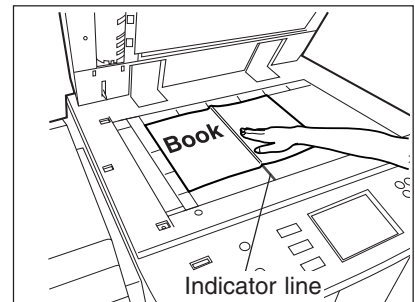

### 3. DUPLEX COPYING (1-SIDED, 2-SIDED, BOOK-TYPE) (Cont.)

**7** Turn to the next page, set the book again and press the **START** key.

- Repeat the procedure above until all your originals have been scanned.

**8** After all your originals have been scanned, press the **FINISHED** key.

- Press the **COPY FINAL PAGE** key if the last original has only one page.

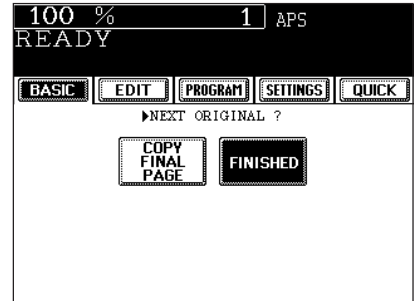

# 4. COPY DENSITY ADJUSTMENT

There are two types of image density adjustments: automatic mode (default setting) and manual mode. In the automatic mode, the sensors automatically detect the density of each original and select the optimum image density. In the manual mode, you can select the desired level of image density. It is recommended that lighter-density original be copied in the manual copy density mode.

## Automatic Copy Density Mode

- 1 Place paper in the drawer(s). ▶ Page 2-4
- 2 Place the original(s). ▶ Page 2-9
- 3 Confirm that “AUTO” is displayed on the basic screen.

- If the automatic density mode is not selected, press the **(MANUAL)** key, then press the **(AUTO)** key on the next screen.

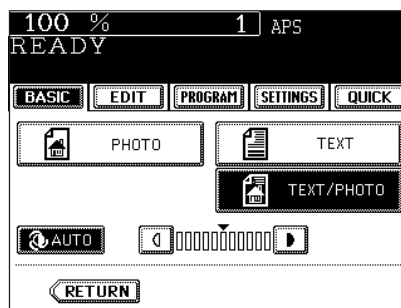
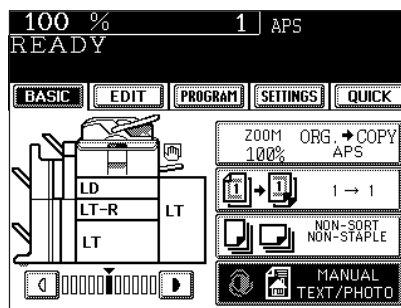
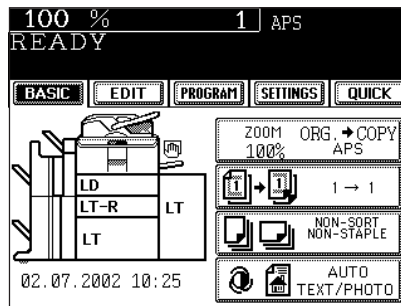

● Select other copy modes as required.

- 4 Press the **(START)** key.

## 4. COPY DENSITY ADJUSTMENT (Cont.)

### Manual Copy Density Mode

**1** Place paper in the drawer(s). ▶ Page 2-4

**2** Place the original(s). ▶ Page 2-9

**3** Press **(AUTO)** on the basic screen.

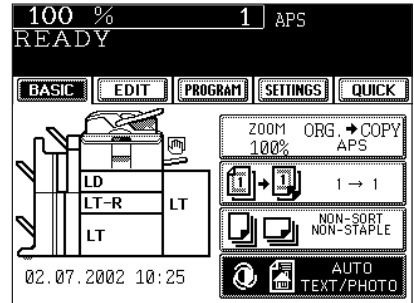

**4** Press either **(◀)** or **(▶)** key to adjust the copy density to the desired level.

- Each time you press the **(◀)** or **(▶)** key, your copies will become lighter or darker, respectively.

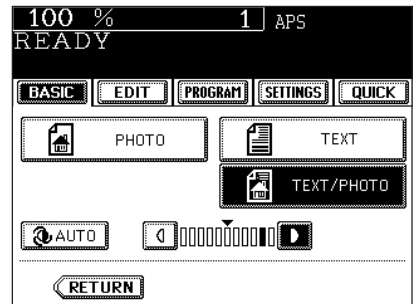

- When the DENSITY LEVEL key is shown on the lower left of the screen, you can adjust the density manually on the basic screen.

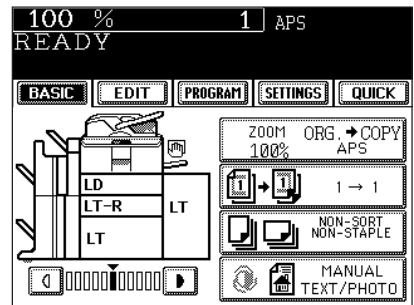

● Select other copy modes as required.

**5** Press the **(START)** key.

# 5. SELECTING ORIGINAL MODE

According to the type of your originals, you can choose among the three image types: Photo, Text or Text/Photo (default setting). The Photo mode is suitable for copying photo originals whereas the Text mode is preferable for copying originals containing text only (or text and line artwork only). The Text/Photo mode is to be selected for originals containing photo and text mixed together.

- 1 Place paper in the drawer(s). ► Page2-4
- 2 Place the original(s). ► Page2-9
- 3 Press the key (shaded) on the right basic screen.

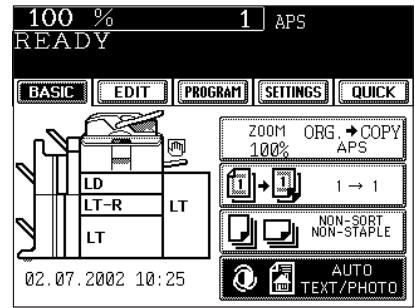

- 4 Choose the desired image type mode by pressing one of the **PHOTO**, **TEXT**, and **TEXT/PHOTO** keys.

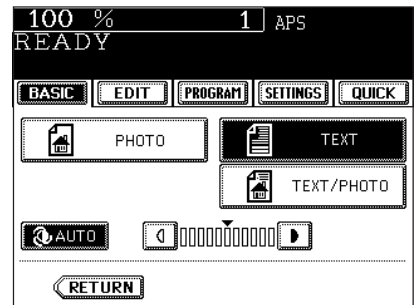

- Select other copy modes as required.

- 5 Press the **START** key.

## Tip

The amount of toner consumed varies depending on the selected image of toner mode. ► Page 7-8  
-The amount of toner consumed by copying the same original is in the following order:  
'PHOTO' < 'TEXT/PHOTO' < 'TEXT'  
(Lest to most consumed toner)

## 6. QUICK ACCESS MENU

Finishing copy and duplex modes can be performed at the same time on one display by pressing the **QUICK** button. The character and button sizes are enlarged, and the white characters are displayed on the black background in order that you can easily operate the copier.

**1** Place paper in the drawer(s). ► Page2-4

**3** **2** Place the original(s). ► Page2-9

**3** Press the **QUICK** button to display the menu shown on the right, then press a button to perform one of the functions.

- The right menu shows “Non-sort and non-staple” and “one side of the original is copied on one side of a sheet of paper.”
- For the details of the functions, refer to the pages below.

[Finishing Mode]

Staple sort (staple at one corner) ► Page 6-4

Sort ► Page 6-3

[Duplex Mode] ► Page3-7

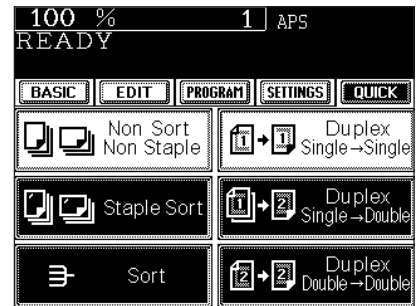

### Tip

For the functions of the finishing and duplex modes, which are not shown on the display, set them on the basic screen.

- Finishing mode setting ► Page 6-2
- Duplex copying ► Page 3-7

- Set up other copying modes as required.

**4** Press the **START** key.



# 4. USING THE EDITING FUNCTIONS

1. Image shift .....	4-2
2. Edge erase .....	4-4
3. Dual-page .....	4-5
4. X-Y zoom .....	4-7
5. Image editing .....	4-8
- Trimming/Masking .....	4-8
- Mirror image .....	4-10
- Negative/Positive reversal .....	4-11
6. 2 IN 1 / 4 IN 1 .....	4-12
7. Copying with annotation .....	4-14
8. Page numbering copying .....	4-15
9. Magazine sort (from the editing menu) .....	4-16
10. Cover copying .....	4-18
11. Sheet insertion copying .....	4-20
12. Tab paper mode .....	4-22
13. Document storage .....	4-28
14. Overlay .....	4-30
15. Sharpness adjustment .....	4-33
16. Direction of duplex copy images (Rotation) .....	4-34

# 1. IMAGE SHIFT

A margin for binding is created by shifting the original image to either the right or left side. You can also create binding margins in the center (inner margin) when using Book-Type Originals to 2-sided copies (▶ Page 3-8).

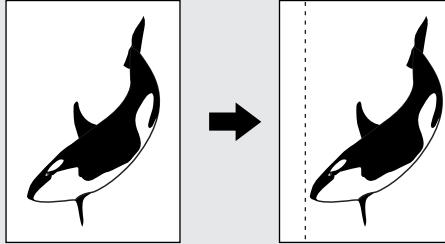

4

## Providing Right or Left Margin

- 1 Place paper in the drawer(s).** ▶ Page 2-4  
- When using this mode in bypass copying, be sure to specify the paper size. ▶ Page 5 -10, 5 -11
- 2 Place the original(s).** ▶ Page 2-9
- 3 Press the **EDIT** key to enter the edit menu, and press the **IMAGE SHIFT** key.**
- 4 Press the **LEFT** or **RIGHT** key according to your desired binding side.**

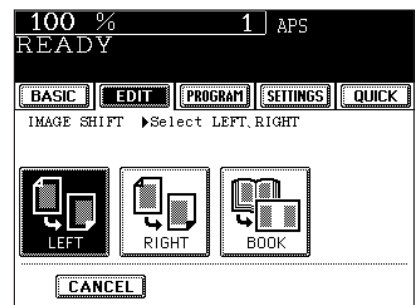
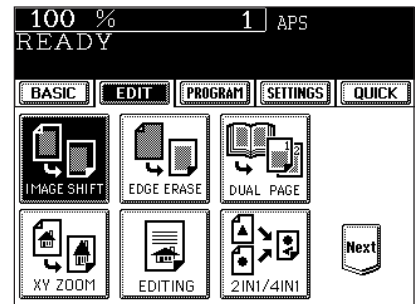

## 5 Adjust the width of the binding margin, then press the **(SET)** key.

- The default width of the margin is 7mm (0.276").
- To adjust the width, press the **(◀0mm)** or **(30mm▶)** key to select the desired number, then press the **(SET)** key.
- In duplex copying, margins on the back are created on the other side of those in the front. Duplex copying ▶ Page 3-7

- Select other copy modes as required.

## 6 Press the **(◀START)** key.

### Providing a Bookbinding Margin

When Book Margin is selected, use it in conjunction with Book-Type Originals to 2-Sided Copies. ▶ Page 3-8

## 1 Press the **(EDIT)** key to enter the edit menu, and press the **(IMAGE SHIFT)** key.

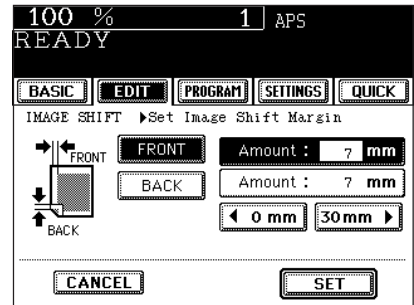

\*25.4mm = 1"

## 2 Press the **(BOOK)** key.

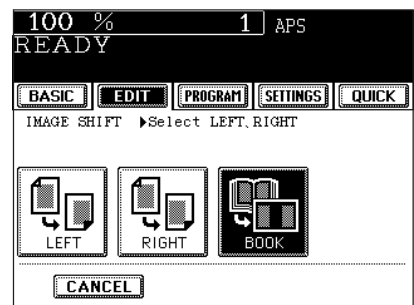
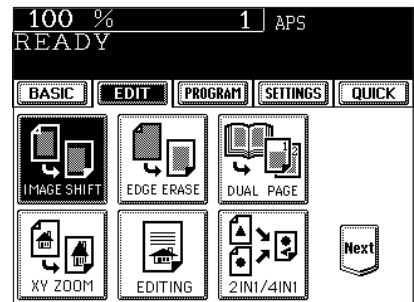

## 3 Adjust the width of the margin, then press the **(SET)** key.

- The default width of the margin is 14mm (0.551").
- To adjust the width, press the **(◀2mm)** or **(30mm▶)** key to select the desired number, then press the **(SET)** key.

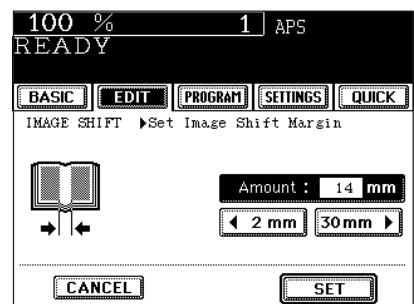

\*25.4mm = 1"

## 2. EDGE ERASE

If your original has a dirty or torn edge, it may be reproduced as a black mark on the copy. In that case, use Edge Erase Copying. A white border is created along the edges of the copy, eliminating those black marks.  
 \* This function is available in only case of the standard-size original.

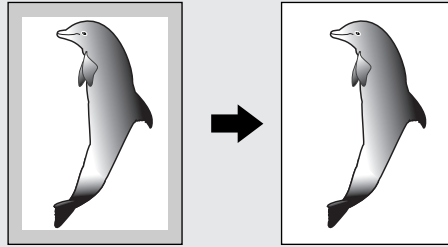

4

**1 Place paper in the drawer(s).** ▶ Page 2-4  
 - When using this mode in bypass copying, be sure to specify the paper size. ▶ Page 5 -10, 5 -11

**2 Place the original(s).** ▶ Page 2-9

**3 Press the **EDIT** key to enter the edit menu, and press the **EDGE ERASE** key.**

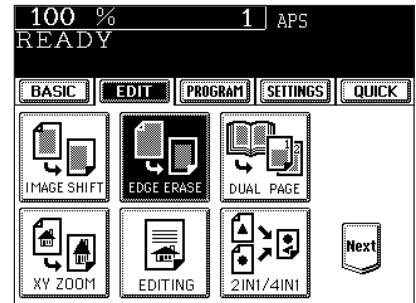

**4 Adjust the width of the white border, then press the **SET** key.**

- The default width of the white border is 5 mm (0.197").
- To adjust the width, press the **◀ 5mm** or **20mm ▶** key to select the desired number, then press the **SET** key.

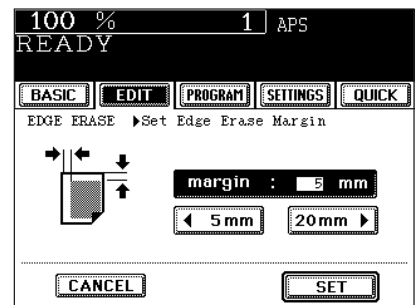

\*25.4mm = 1"

- Select other copy modes as required.

**5 Press the **START** key.**

# 3. DUAL-PAGE

Utilizing this feature allows the facing pages of a book or magazine to be copied page by page onto two separate sheets of paper or duplex-copied on one sheet. There is no need to move the original on the glass. You can also place a pair of LT (or A4, B5) sized originals side by side and copy them on separate sheets of paper.

\* Only LT, A4 or B5 sized sheets of paper can be used in this mode.

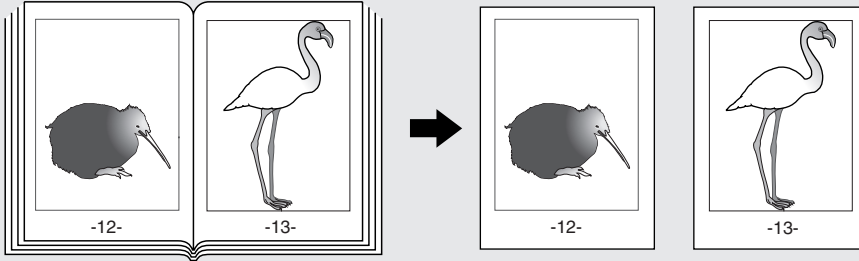

## 1 Place paper in the drawer(s). ► Page 2-4

- When using this mode in bypass copying, be sure to specify the paper size. ► Page 5 -10, 5 -11

## 2 Press the **EDIT** key to enter the edit menu, and press the **DUAL PAGE** key.

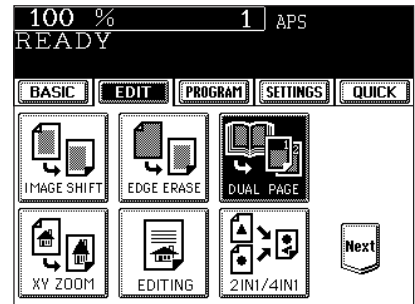

## 3 Press the **1 SIDE** (or **2 SIDE**) key.

- Select the **1 SIDE** key to make copies of the facing pages on two separate sheets of paper page by page. Select the **2 SIDE** key to make duplex copies of them on one sheet.

## 4 Press the **BASIC** key to enter the basic menu, then select LT (or A4, B5) copy size. ► Page 3-2

## 5 If you need a binding margin, set the left margin. ► Page 4-2

- Select other copy modes as required.

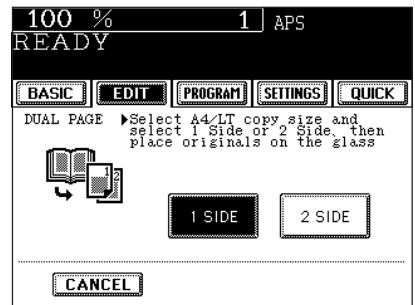

### 3. DUAL PAGE (Cont.)

**6** Place the first page(s) to be copied on the glass, and press the **START** key.

- If you do not copy your originals from the first page, the copies will not be arranged in the same order as the original.
- Center the book on the yellow indicator line with the bottom toward you.

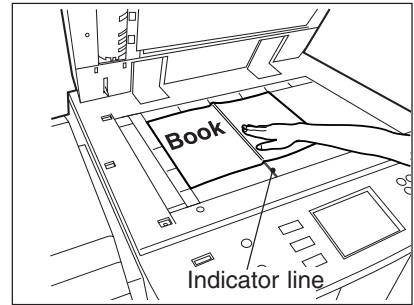

**7** Turn to the next page, set the book again and press the **START** key.

- Repeat the above procedure until all your originals have been scanned.

**8** After all your originals have been scanned, press the **FINISHED** key.

- Press the **COPY FINAL PAGE** key if the last original has only one page.

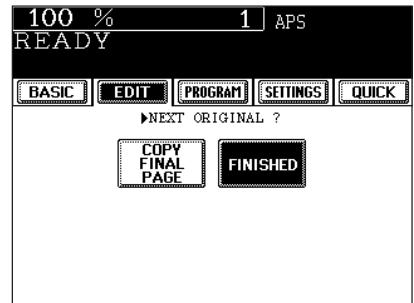

## 4. X-Y ZOOM

You can make copies with different reproduction ratios set for the X (horizontal) and Y (vertical) directions, respectively.

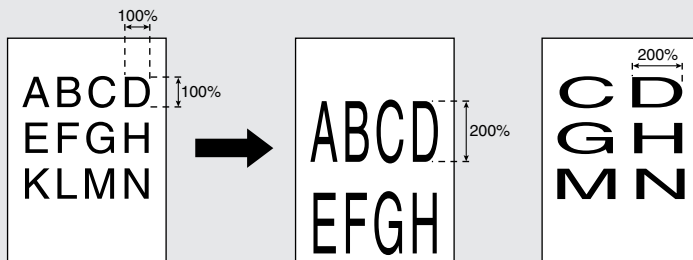

- 1 Place paper in the drawer(s). ▶ Page 2-4
- 2 Place the original(s). ▶ Page 2-9
- 3 Press the **EDIT** key to enter the edit menu, and press the **XY ZOOM** key.

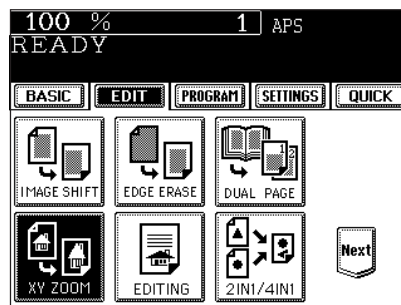

- 4 Set the reproduction ratios for the X (horizontal) and Y (vertical) directions, respectively.

- Using the **25%<** and **>400%** keys on the screen (Use **100%** key if you want the same size as original.), set the reproduction ratio for X and press the upper **SET** key. Similarly, set the reproduction ratio for Y.
- When placing the original on the reversing automatic document feeder, set the reproduction ratios from 25 to 200%.

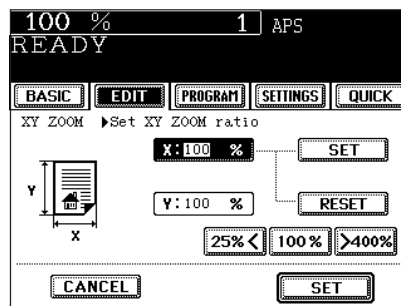

- 5 Press the lower **SET** key.

- Select other copy modes as required.

- 6 Press the **START** key.

# 5. IMAGE EDITING

## Trimming/Masking

You can select an area on an original and copy it with the area trimmed (only the inside of the area copied) or masked (only the outside of the area copied). Four rectangular areas can be specified on an original.

\* Image editing is only possible with standard sized originals.

\* If the settings of the original and copy sizes are not made appropriately, the image may not be copied completely.

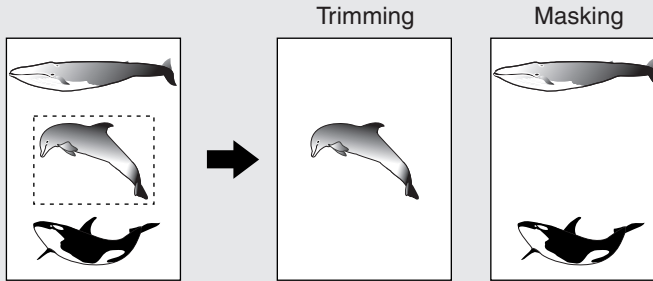

4

**1** Place paper in the drawer(s). ► Page 2-4  
- When using this mode in bypass copying, be sure to specify the paper size. ► Page 5- 10, 5 -11

**2** Press the **EDIT** key to enter the edit menu, and press the **EDITING** key.

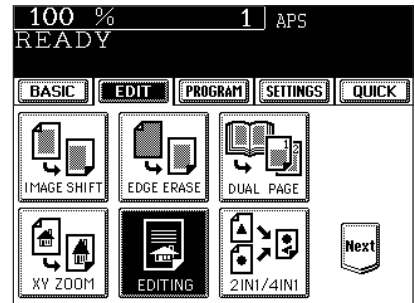

**3** Press the **TRIM** (or **MASK**) key.

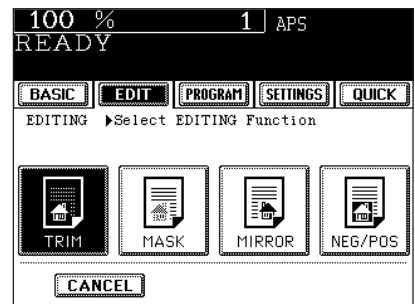



## 4 Place an original on the glass to specify the area.

- Set the original face up with the bottom toward you, fit its top left corner against the top left corner of the glass, and align it with the original scale.

## 5 Using the original scale on the left and the inner (top) scale, read the position of the desired area as follows:

- X1 Distance from the top left to the left edge of the specified area.
- X2 Distance from the top left to the right edge of the specified area.
- Y1 Distance from the top left to the upper edge of the specified area.
- Y2 Distance from the top left to the lower edge of the specified area.

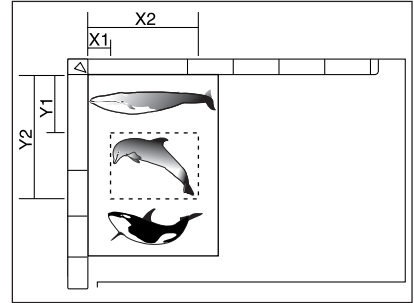

### Tip

Four rectangular areas can be specified on an original.

## 6 Enter the distance values read in step 5 for the specified area.

- Key in the value for X1 with the digital keys and press the upper **SET** key.
- Similarly, set the values for X2, Y1 and Y2.
- When setting X1, X2, Y1 and Y2, the original scale automatically changes to the next original scale. Set the next original scale as same procedure.

## 7 Press the lower **SET** key.

## 8 Place the original. (Sheet original ► Page 2-10)

- place the original(s) on the glass with the face down, with its bottom toward you, with its top left aligned against the original scale on the left side.

- Select other copy modes as required.

## 9 Press the **START** key.

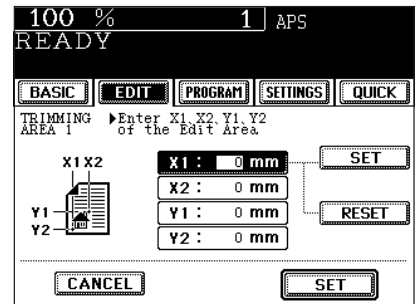

\*25.4mm = 1"

## 5. IMAGE EDITING (Cont.)

### Mirror Image

Copies are made with images completely reversed in terms of right and left.

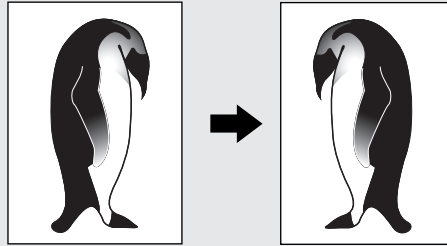

**1** Place paper in the drawer(s). ▶ Page 2-4

- When using this mode in bypass copying, be sure to specify the paper size. ▶ Page 5-10, 5-11

**2** Place the original(s). ▶ Page 2-9

**3** Press the **EDIT** key to enter the edit menu, and press the **EDITING** key.

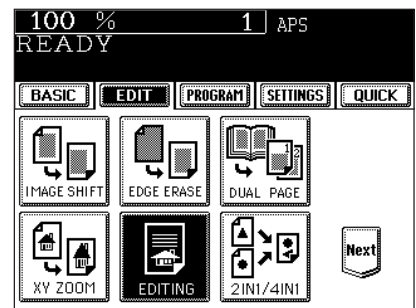

**4** Press the **MIRROR** key.

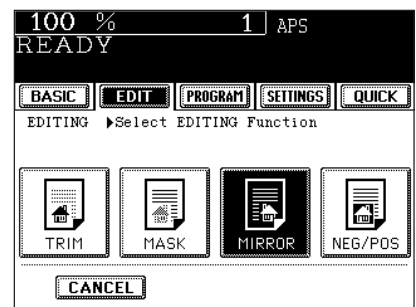

● Select other copy modes as required.

**5** Press the **START** key.

## Negative/Positive Reversal

The white area of originals copying black, and the black area of originals copying white.

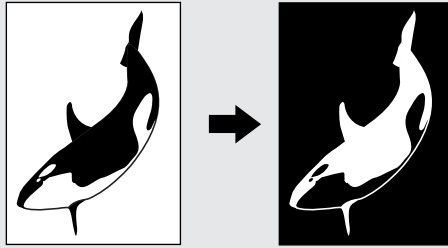

- 1 Place paper in the drawer(s). ▶ Page 2-4
- 2 Place the original(s). ▶ Page 2-9
- 3 Press the **EDIT** key to enter the edit menu, and press the **EDITING** key.

- 4 Press the **NEG/POS** key.

● Select other copy modes as required.

- 5 Press the **START** key.

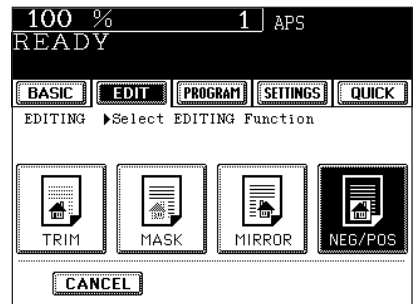
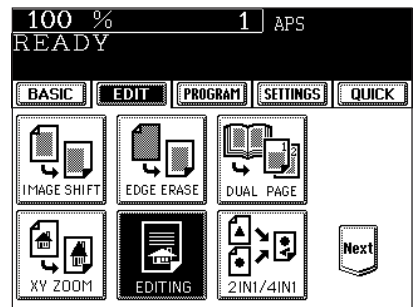

# 6. 2 IN 1 / 4 IN 1

This feature allows multiple originals to be reduced and copied onto a single sheet which size is the same size as the original. There are two modes: 2 IN 1 copying, where two originals are reduced and copied onto a single sheet, and 4 IN 1 copying, where four originals are reduced and copied onto a single sheet. In addition, duplex 2 IN 1 / 4 IN 1 modes are available, where four/eight originals can be copied to two sides of a single sheet of paper.

\* 2 IN 1/4 IN 1 duplex copying mode requires the optional automatic duplexer to be installed.

4

The combination of page arrangement differs depending on the direction of originals set on the reversing automatic document feeder.

● 2IN1

Originals

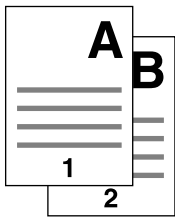

Copy

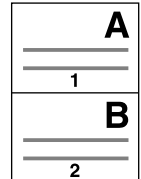
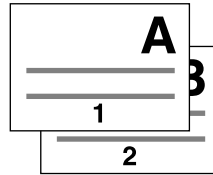
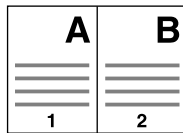

● 4IN1

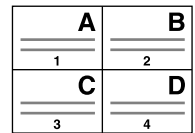
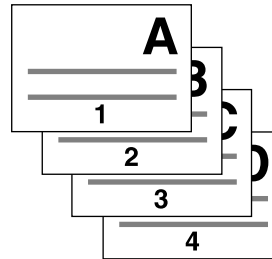
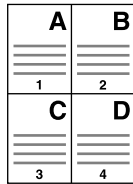
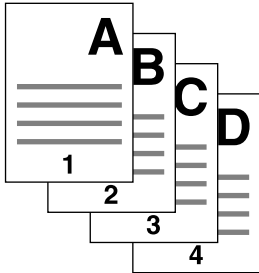

● 2IN1 DUPLEX

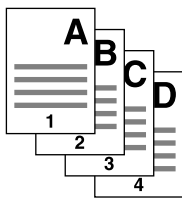

SIDE 1

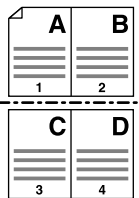

SIDE 2

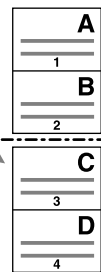
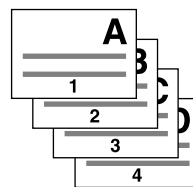

● 4IN1 DUPLEX

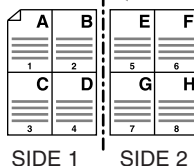
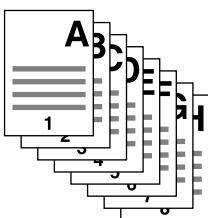

SIDE 1 | SIDE 2

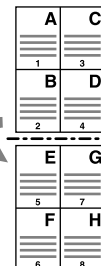
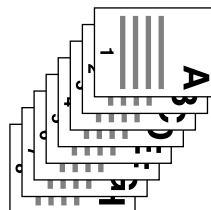

When a copy is turned with the line ——— as a pivot, originals are printed on side 2 (back face) as shown.

# 1 Place paper in the drawer(s). ▶ Page 2-4

- When using this mode in bypass copying, be sure to specify the paper size. ▶ Page 5-10, 5-11

## Tip

To make copies onto paper which is not the same size as originals, press the (ZOOM...) key to enter the right menu, and press the size you desire and the (AMS) key.

# 2 Place the original(s). ▶ Page 2-9

# 3 Press the (EDIT) key to enter the edit menu, and press the (2IN1/4IN1) key.

# 4 Select the type of image combination.

- Press the (2IN1) (or (4IN1), (2IN1 DUPLEX) or (4IN1 DUPLEX)) key.

# 5 Select the type of the original.

- Press the (1 SIDE) (or (2 SIDE)) key.

● Select other copy modes as required.

# 6 Press the (START) key.

- When placing an original on the glass, perform steps 5 and 6 on page 2-3 as needed.

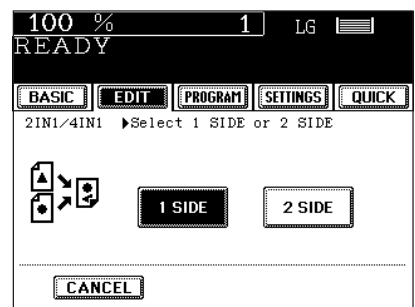
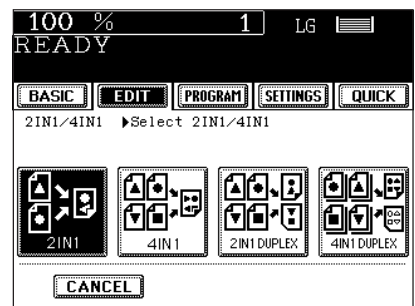
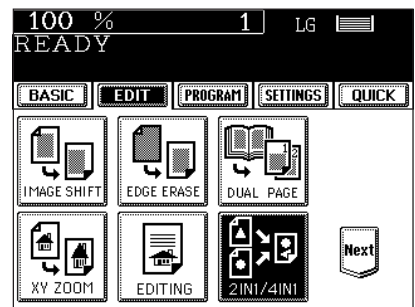
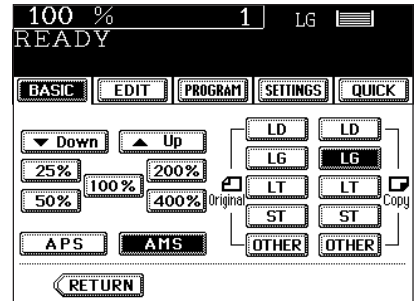

# 7. COPYING WITH ANNOTATION

Copies are made with the current date and time, at which they are made, printed on the copy.

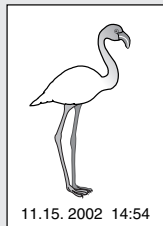

Date and time printed at the bottom of the portrait copy

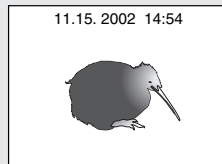

Date and time printed at the top of the landscape copy

4

- 1 Place paper in the drawer(s). ▶ Page 2-4
- 2 Place the original(s). ▶ Page 2-9
- 3 Press the **EDIT** key to enter the edit menu, and press the **ANNOTATION** key.

- If the desired function keys are not displayed, press the **Next** or **Pre** key to change the menu screen.

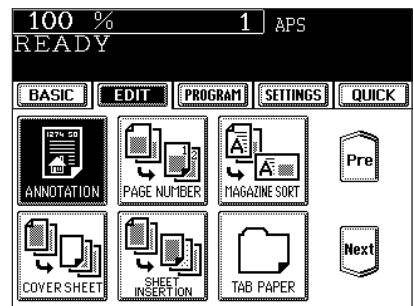

- 4 Select the orientation (Short edge or Long edge) and position (UPPER or LOWER) of the date and time to be printed. Then, press the **SET** key.

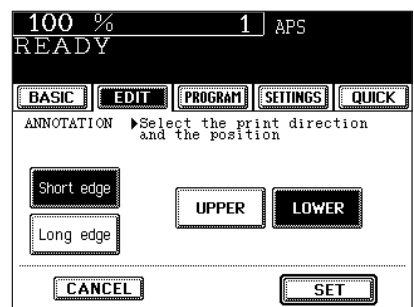

● Select other copy modes as required.

- 5 Press the **START** key.

# 8. PAGE NUMBERING COPYING

This feature allows numbers to be added at specified position to copies.

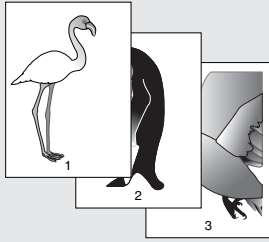

Page number printed at the bottom center on the portrait copy.

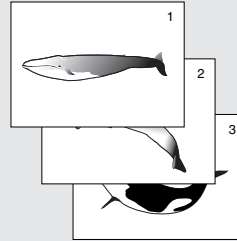

Page number printed at the top right on the landscape copy.

**1** Place paper in the drawer(s). ▶ Page 2-4

**2** Place the original(s). ▶ Page 2-9

**3** Press the **EDIT** key to enter the edit menu, and press the **PAGE NUMBER** key.

- If the desired function keys are not displayed, press the **Next** or **Pre** key to change the menu screen.

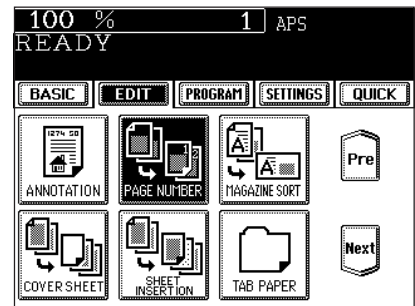

**4** Select the orientation (**Short edge** or **Long edge**) and position of the page number to be printed. Then, press the **SET** key.

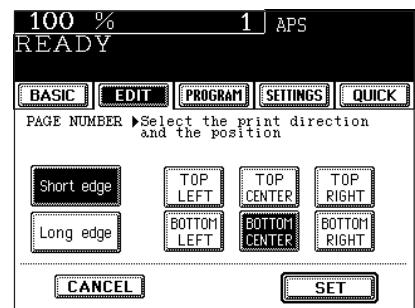

**5** Key in the starting page number.  
- If the start page number is "1", just press the **SET** key.

● Select other copy modes as required.

**6** Press the **START** key.

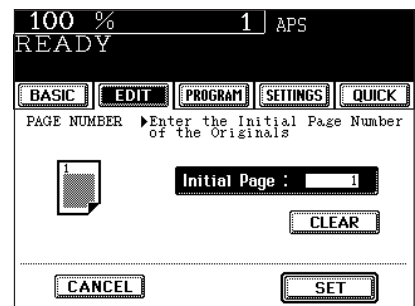

# 9. MAGAZINE SORT (FROM THE EDITING MENU)

The magazine sort mode allows 1-sided originals to be copied and sorted so that they can be folded and bound along a center line like typical magazines or booklets.

- Example of copying a 12-page document

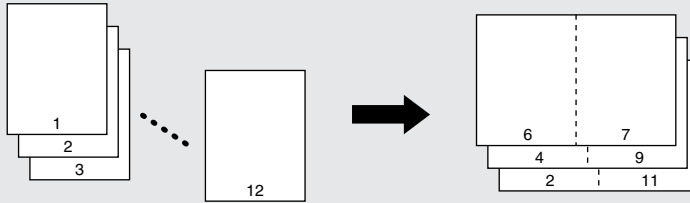

- If used in combination with the optional saddle stitch finisher (AR-F12), copies can be automatically folded in half and stapled along their center line. LD, LT-R, A3, A4-R, B4 are available.

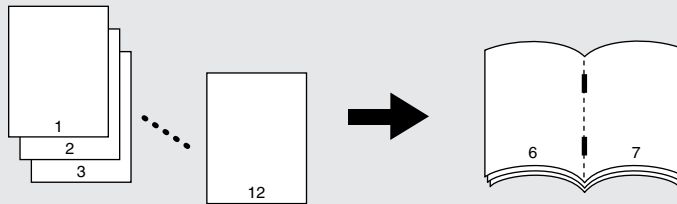

\* Magazine Sort can be accessed from two locations. For the mode operated from the BASIC menu when the finisher (optional) is installed, see page 6-6.

4

**1 Place paper in the drawer(s).** ▶ Page 2-4

**2 Select the paper type.**  
 For drawer feeding ▶ Page 3-2 (step 3)  
 For bypass feeding ▶ Page 5-9 (step 4)

**3 Place the original(s).** ▶ Page 2-9

- When placing them in the reversing automatic document feeder, set them by referring to the order of pages in the illustrations above.
- When placing them on the glass, place the first page of the originals first.

**4 Press the **EDIT** key to enter the edit menu, and press the **MAGAZINE SORT** key.**

- If the desired function keys are not displayed, press the **Next** or **Pre** key to change the menu screen.

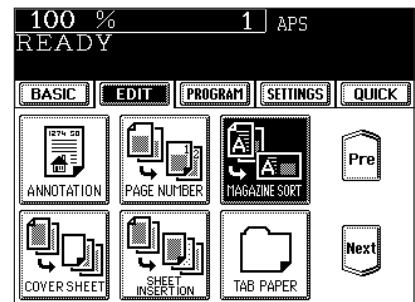



## 5 Adjust the binding margin and press the **SET** key.

- The default width of the margin is 2 mm (0.08").
- To adjust the width, press the **◀2mm** or **30mm▶** key to select the desired number, then press the **SET** key.

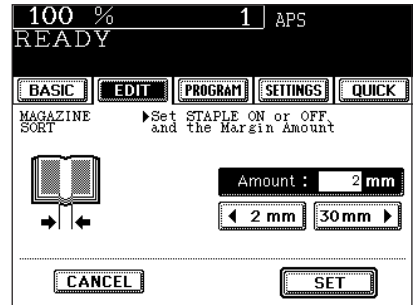

- If the optional saddle stitch finisher (AR-F12) is installed, copies can be automatically stapled along their center line. To have copies stapled, press the **STAPLE ON** key. Maximum number of sheets that can be stapled ► Page 6-7

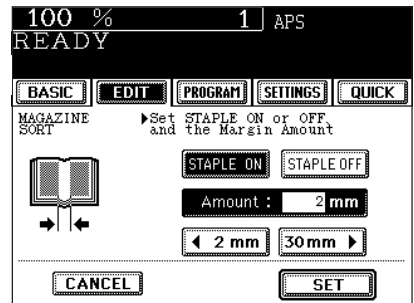

\*25.4mm = 1"

- Select other copy modes as required.

## 6 Press the **START** key.

- When placing an original on the glass, perform steps 5 and 6 on page 2-3 as needed.

# 10. COVER COPYING

A top cover and/or back cover (special sheets, e.g. colored paper) can be added to each set of copies.

- Adding a blank cover
- Adding a copied cover
- Adding a blank cover and a blank back cover
- Adding a copied cover and blank back cover

Example of adding a blank cover

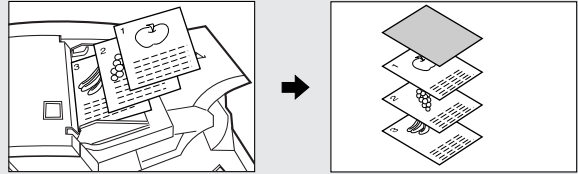

Example of adding a copied cover

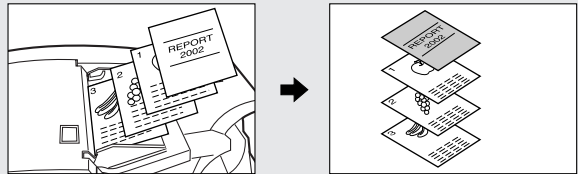

Example of adding a blank cover and a blank back cover

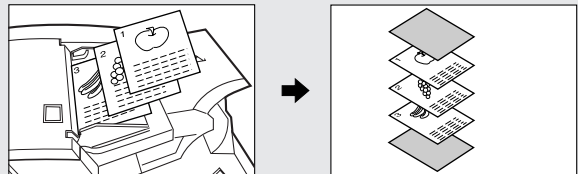

Example of adding a copied top and blank back cover

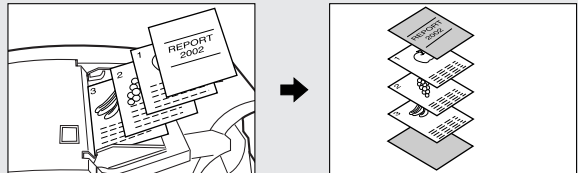

## Tip

When using the cover feature, make certain all paper sources are of the same orientation and the size. This includes specified drawer, bypass and inserter (optional).

## 1 Place the cover sheet in the drawer for cover sheet or on the bypass guide.

- When placing it in the drawer for the cover sheet, it is necessary to set the paper type (cover sheet), size and weight. Setting the drawer for special uses. ► Page 2-7
- When placing it on the bypass guide, it is necessary to set the paper size and weight. ► Page 5-10

## 2 Place, or confirm that if there is, paper (other than cover paper) in the drawer(s). ► Page 2-4

- Place the paper of the same size and the same direction as that of cover.

## 3 Place the original(s). ► Page 2-9

- When placing an original on the glass, place the first page of your originals first.

**4** Press the **EDIT** key to enter the edit menu, and press the **COVER SHEET** key.

- If the desired function keys are not displayed, press the **Next** or **Pre** key to change the menu screen.

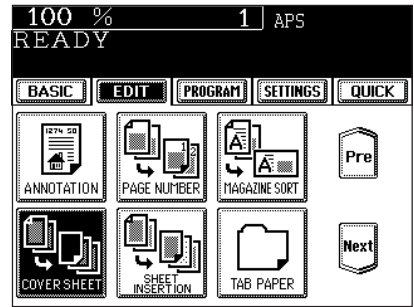

**5** Select the desired cover sheet key:

To add a blank top cover: **TOP BLANK**

To add a copied top cover: **TOP COPIED**

To add blank top and back covers: **BOTH BLANK**

To add copied top and blank back covers:

**TOP COPIED BACK BLANK**

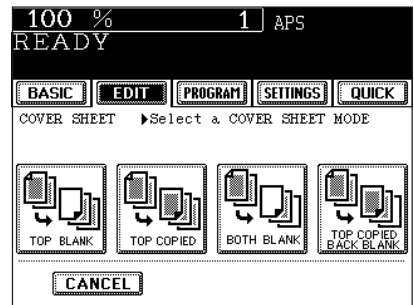

**6** Press the **BASIC** key to enter the basic menu, and select the paper source of the same size and direction as the cover sheet paper.

- Setting the drawer for cover sheet ▶ Page 2-6

- Setting the bypass guide ▶ Page 5-8

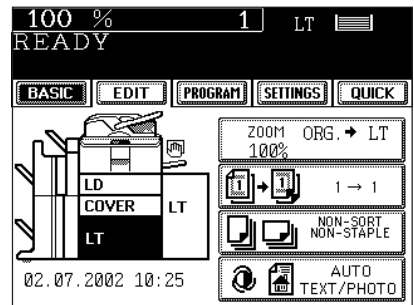

● Select other copy modes as required.

**7** Press the **START** key.

**Tip**

When **TOP COPIED** key or **TOP COPIED BACK BLANK** key is selected, the cover sheet can be copied only on the top face (single-side) though 1-Sided Original to 2-Sided Copy is used.

# 11. SHEET INSERTION COPYING

Special sheets of paper (such as colored paper) are inserted into a set of copies at specified pages.

There are two sheet Insertion modes available:

- Inserting blank sheets before specified pages
- Inserting copied sheets at specified pages

Example of inserting a blank before the specified page

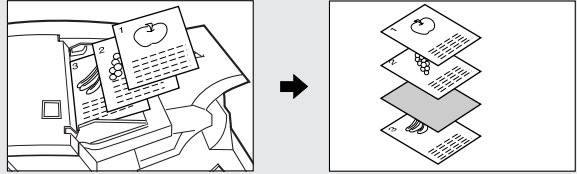

Example of inserting a copied sheet before the specified page

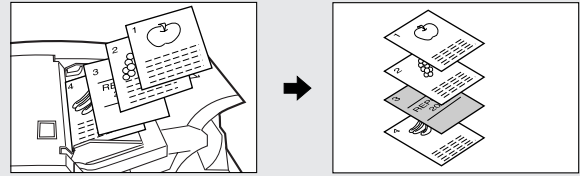

## Tip

You can have 2 Insertion Sheet paper sources. To make Sheet Insertion copies, you have to set the Insertion Sheet paper source(s) and the plain paper source to the same paper size and direction.

4

**1** Place sheets of paper in the drawer for the sheet insertion. ► Page 2-6

**2** Place plain paper in the drawer(s). ( The same size and direction on Step 1)

**3** Place the original(s). ► Page 2-9

**4** Press the **EDIT** key to enter the edit menu, and press the **SHEET INSERTION** key.

- If the desired function keys are not displayed, press the **Next** or **Pre** key to change the menu screen.

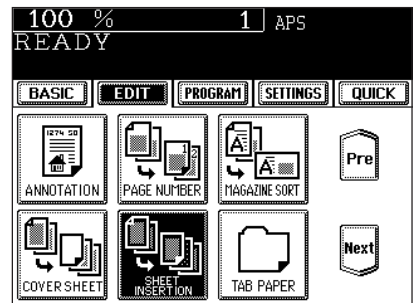

**5** Press **COPIED** or **BLANK** key.

To insert copied sheets at specified pages: **COPIED**  
To insert blank sheets before specified papers: **BLANK**

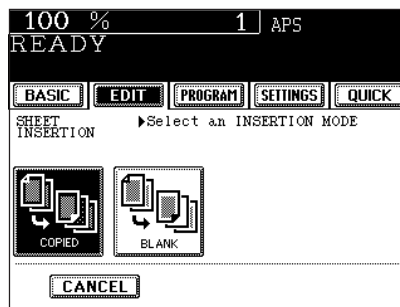

**6** Key in the desired page number (no more than 3 digits) for insertion and press the upper **SET** key.

- On the display, the page where the first sheet will be inserted is shown. The example on the right shows the first sheet inserted at (or before) page 10.
- To specify the next and subsequent pages, repeat step 6. Up to 15 pages can be specified.
- To have different sheets inserted than Insert source 1, select **INSERT SOURCE 2** and similarly key in the pages where you want the sheets inserted, then press the upper **SET** key.

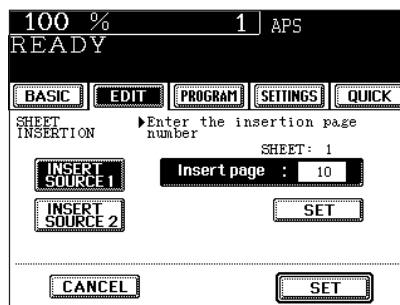

**7** After you have finished specifying the insertion pages, press the lower **SET** key.

**8** Select the number of copies (or sets).

- Select other copy modes as required.

**9** Press the **START** key.

# 12. TAB PAPER MODE

Tab paper copy and insertion are available.

- ① Tab Paper Copy: Copying on tab paper
- ② Tab Paper Insertion: Inserting blank tab paper prior to a selected page
- ③ Tab Paper Insertion and Copy: Combination of copying on tab paper and inserting tab paper

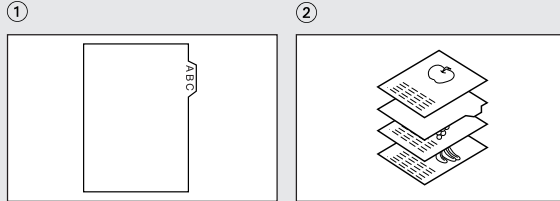

- To copy on tab paper, adjust the tab width.
- \* Place tab paper in the second drawer or the bypass guide.
- \* Only LT and A4 can be used in this mode.

4

## Setting Tab Paper in the Drawer

### 1 Pull the second drawer out.

-Do not touch the slide rail of the drawer.

### 2 Insert the back guide exclusively use for the tab paper into the slit hole of LT-TAB (or A4-TAB).

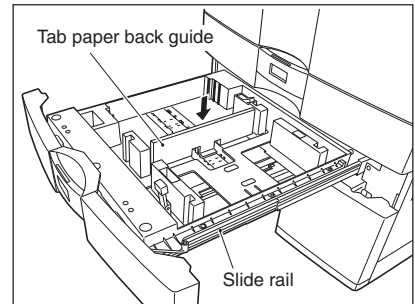

### 3 Align the tab paper with the original.

● Originals

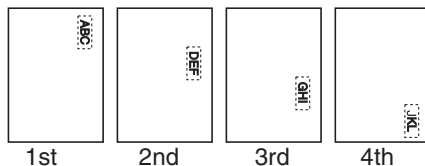

● Sheets of tab paper

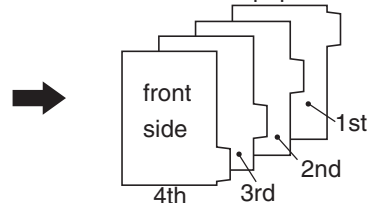

### 4 Place the tab paper face down in the drawer.

### 5 Return the drawer into the copier.

**Tip**

Be careful not to let your fingers be caught when closing the drawer.

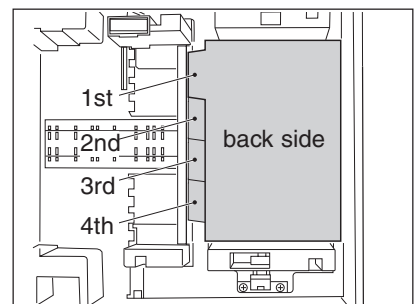

## Setting Tab Paper in the Bypass Guide

### 1 Align the tab paper with the original.

- Originals

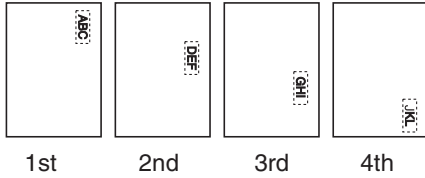

- Sheets of tab paper

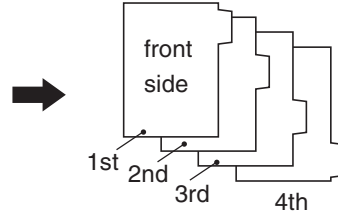

### 2 Place the tab paper with face up on the bypass guide.

### 3 Perform step 3 and 4 on page 5-9.

-Be sure to select 'Tab Paper' for the paper type.

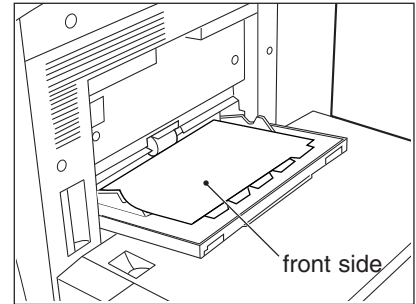

4

## Tab Width Adjustment

To copy on tab paper, adjust both the tab width and the shift width for the drawer and the bypass guide respectively.

- The range of the tab width/the shift width

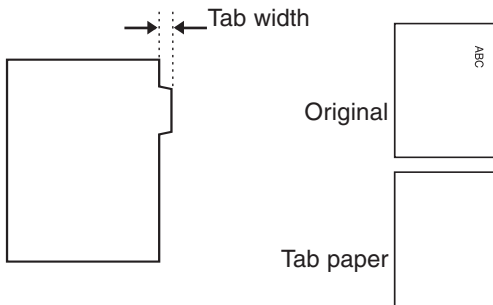

\*The shift width means the distance the image should be shifted when copied on the tab paper.

### 1 Press the **EDIT** key to enter the edit menu, and press the **TAB PAPER** key.

- If the desired function keys are not displayed, press the **Next** or **Pre** key to change the menu screen.

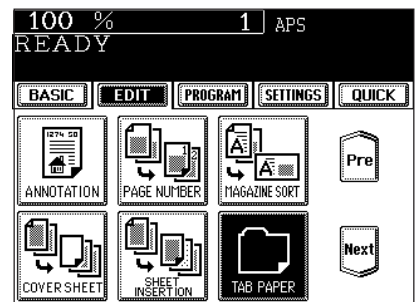

## 12. TAB PAPER MODE(Cont.)

**2** Press the **TAB EXTENSION** key.

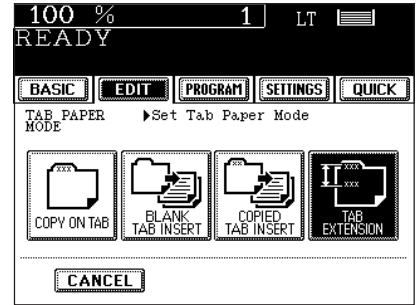

**3** Press the **CASSETTE** key (or the **BYPASS FEED** key), then adjust the tab extension (tab width) and the shift width then press the **SET** key.

- Adjust the tab width and the shift width by means of the **◀ 0mm** key and the **30mm ▶** key.

**Tip**

Unless the tab width has refreshed, the previous value is valid. The initial settings are set to 13mm (0.51") for the tab width and the shift width.

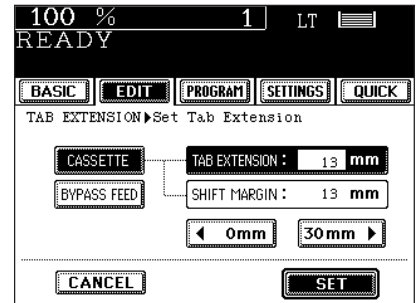

\*25.4mm = 1"

- The range of the tab width/the shift width

	Tab width	Shift width
Drawer	12 to 17mm (0.4" to 0.6")	0 to 30mm (0 to 1.1")
Bypass	10 to 20mm (0.4" to 0.7")	0 to 30mm (0 to 1.1")

- Measuring the tab width / the shift width

The tab width and the shift width can be measured on the original glass. Place tab paper for measuring the tab width and place original for measuring the shift width on the original glass as indicated on the right. The marks of the original scale have a 2mm pitch.

- Measuring the tab width (Place tab paper)

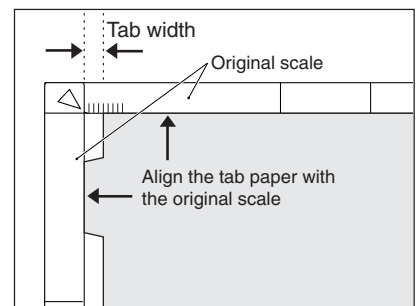

- Measuring the shift width (Place original)

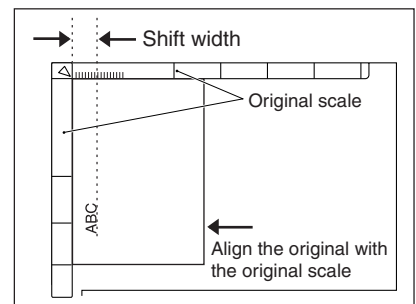



## ① Tab Paper Copying

Copying on tab paper at the value in the tab width set mode (▶ Page 4-23).

### 1 Place tab paper in the drawer or the bypass guide.

- For placing it in the drawer ▶ Page 4-22
- For placing it in the bypass guide ▶ Page 4-23

### 2 Place the original(s). ▶ Page 2-9

### 3 Press the **EDIT** key to enter the edit menu, and press the **TAB PAPER** key.

- If the desired function keys are not displayed, press the **Next** or **Pre** key to change the menu screen.

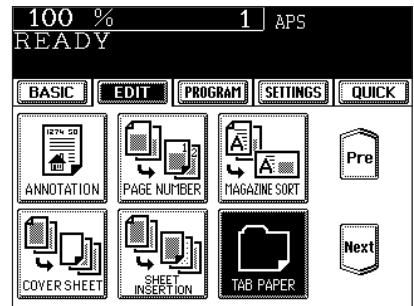

### 4 Press the **COPY ON TAB** key.

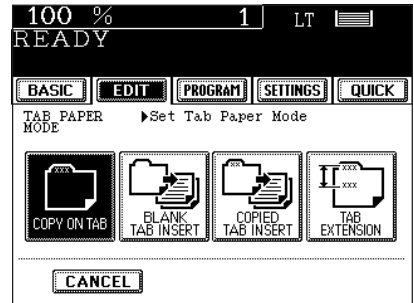

### 5 Press the **SET** key.

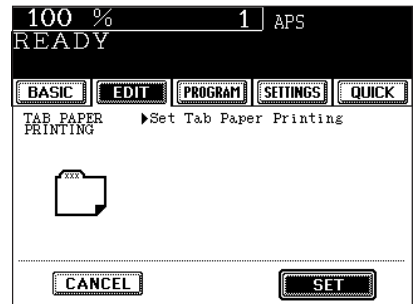

- Select other copy modes as required.

### 6 Press the **START** key.

## 12. TAB PAPER MODE(Cont.)

### ② Tab Paper Insertion

Tab paper (blank) is inserted prior to selected pages. Up to 15 sheets of tab paper can be inserted.

#### 1 Place tab paper in the drawer or the bypass guide.

- For placing it in the drawer ▶ Page 4-22
- For placing it in the bypass guide ▶ Page 4-23

#### 2 Place the original(s). ▶ Page 2-9

#### 3 Press the **EDIT** key to enter the edit menu, and press the **TAB PAPER** key.

- If the desired function keys are not displayed, press the **Next** or **Pre** key to change the menu screen.

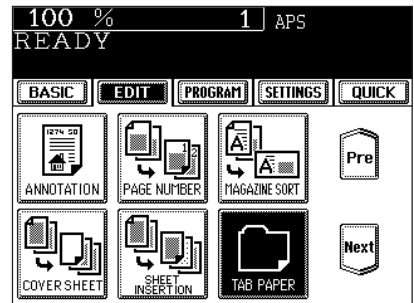

#### 4 Press the **BLANK TAB INSERT** key.

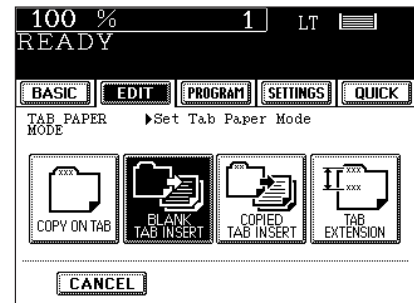

#### 5 Key in the page number you selected for the insertion of the tab paper, then press the upper **SET** key.

- When two sheets of paper or more are inserted, repeat this operation. Up to 15 sheets of paper can be inserted.

#### 6 Press the lower **SET** key.

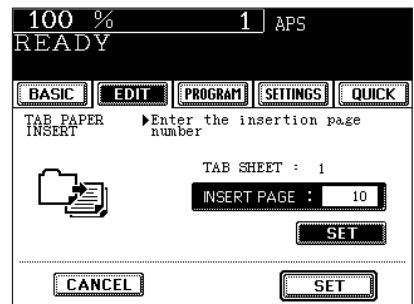

- Select other copy modes as required.

#### 7 Press the **START** key.

### ③ Tab Paper Insertion and Copying

- Copied tab paper is inserted prior to the selected pages. Up to 15 sheets of tab paper can be inserted.

#### 1 Place tab paper in the drawer or the bypass guide.

- For placing it in the drawer ▶ Page 4-22
- For placing it in the bypass guide ▶ Page 4-23

#### 2 Place the original(s). ▶ Page 2-9

#### 3 Press the **EDIT** key to enter the edit menu, and press the **TAB PAPER** key.

- If the desired function keys are not displayed, press the **Next** or **Pre** key to change the menu screen.

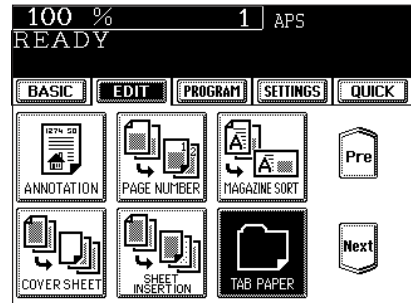

#### 4 Press the **COPIED TAB INSERT** key.

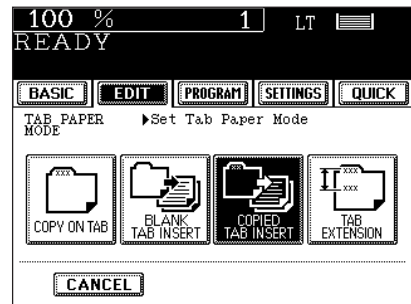

#### 5 Key in the page number you selected for the insertion of the tab paper, then press the upper **SET** key.

- When two sheets of paper or more are inserted, repeat this operation. Up to 15 sheets of paper can be inserted.

#### 6 Press the lower **SET** key.

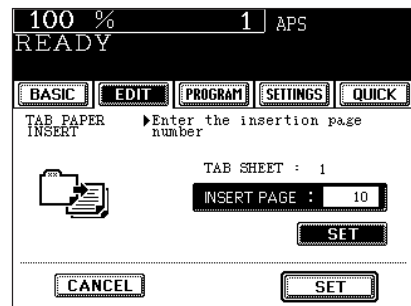

- Select other copy modes as required.

#### 7 Press the **START** key.

# 13. DOCUMENT STORAGE

This feature allows images of the originals to be stored on the hard disk of the copier, and copies can be made from the hard disk later. This copying method consists of the following two modes:

- ① MEMORIZE mode: Stores original images at the specified location of the hard disk.
- ② PRINT mode: Prints the originals stored in the Memorize Mode in ①.

\* Originals can be stored in up to 24 locations.

\* Up to 1,000 original sheets can be stored in each location.

### Tip

Total Document Storage capacity is determined by the size of the documents.

4

## ① Storing Documents in the MEMORIZE Mode

- 1 Place the original(s). ▶ Page 2-9
- 2 Press the **EDIT** key to enter the edit menu, and press the **DOCUMENT STORAGE** key.

- If the desired function keys are not displayed, press the **Next** key to change the menu screen.

- 3 Press the **MEMORIZE** key.

- 4 Press the file name column of the location number (ID) where you want your document stored, key in the file name and press the **SET** key.

- Select any ID where no data has been stored.
- Entering letters ▶ Page 5-28

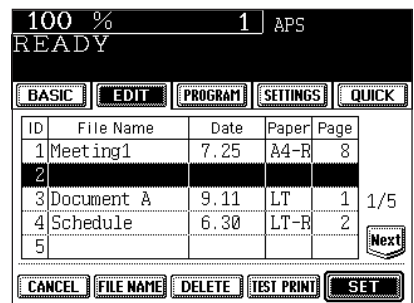
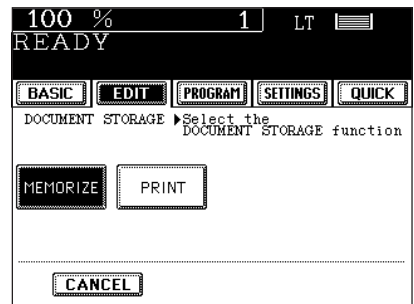
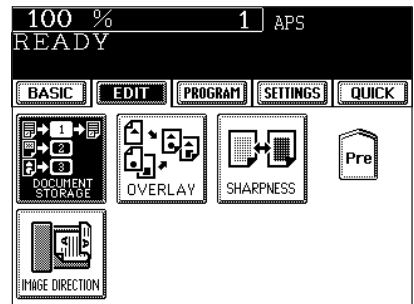

## 5 Press the **START** key.

- The memorization process starts automatically.

### Tips

- To change the file name, select the ID you want to change in the list on the display, press the file name column, delete the file name already entered with the **Space** key in the letter entry screen, then enter a new file name, and press the **SET** key.
- Entering letters ► Page 5-28
- To confirm a memorized job, select the ID from the list on the display and press **TEST PRINT**.
- To delete a memorized job, select the ID from the list on the display and press the **DELETE** key. Then, press the **Delete** key on the next screen.

## ② Making Copies in the PRINT Mode

### 1 Place paper in the drawer(s). ► Page 2-4

### 2 Press the **EDIT** key to enter the edit menu, and press the **DOCUMENT STORAGE** key.

- If the desired function keys are not displayed, press the **Next** key to change the menu screen.

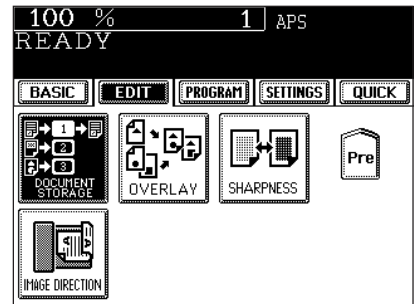

### 3 Press the **PRINT** key.

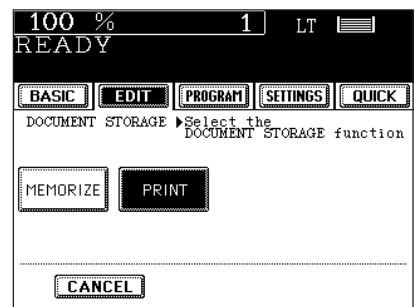

### 4 Select the ID of the job you want to print out, and press the **SET** key.

- The memorized functions are recalled.

- Select other copy modes as required.

### 5 Press the **START** key.

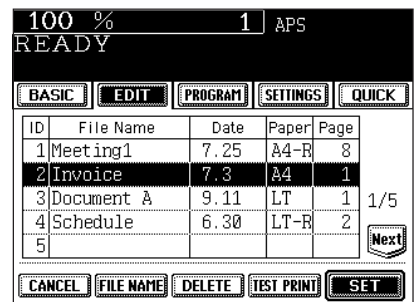

# 14. OVERLAY

This function stores the images that you frequently use and makes copies by overlaying onto the copied originals.

- 24 different images can be stored.

\* The original can be overlaid with the stored image of the same size and in the same orientation.  
(It cannot be adjusted with reduction and enlargement.)

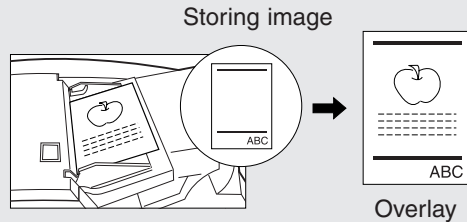

## Storing Image

**1** Place the original you want to have memorized.

▶ Page 2-9

**2** Press the **EDIT** key to enter the edit menu, and press the **OVERLAY** key.

- If the desired function keys are not displayed, press the **Next** key to change the menu screen.

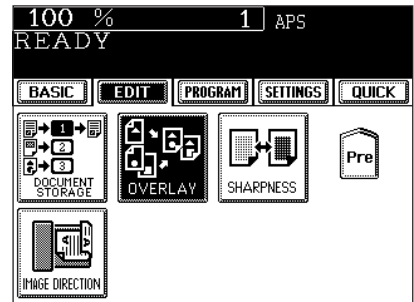

**3** Press the **MEMORIZE** key.

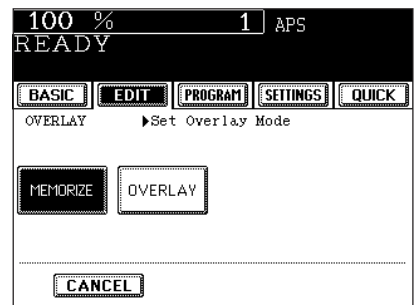

**4** Press the row of the file name list you desire, then press the **FILE NAME** key.

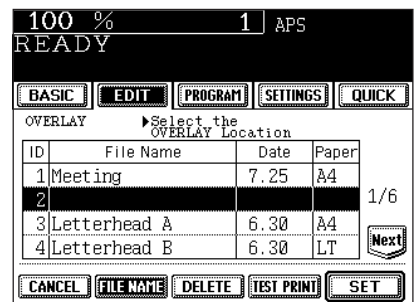

**5** Input the file name with the screen for entering letters and press the **SET** key.

- Entering letters. ► Page 5-28

**6** Press the **START** key.

-The original starts scanning to memorize the image.

**7** The form will be stored as shown on the right.

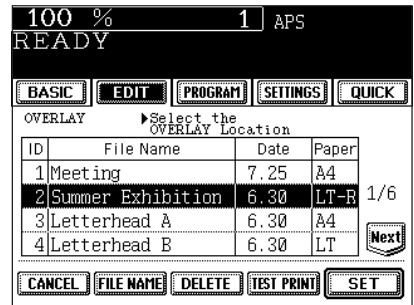
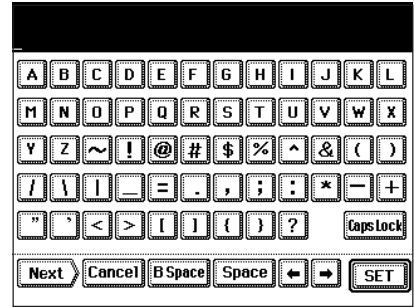

**Confirming Stored Image (Test Print)**

**1** Perform steps 2 and 3. ► Page 4-29

**2** Press the file name you desire (the selected file name will be shaded), then press the **TEST PRINT** key.

- The stored image starts printing out.

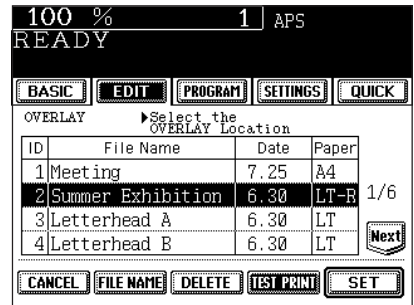

**Deleting Image**

**1** Perform steps 2 to 3. ► Page 4-29

**2** Press the file name you desire ( the selected file name will be shaded), then press the **DELETE** key.

**3** Press the **Delete** key.

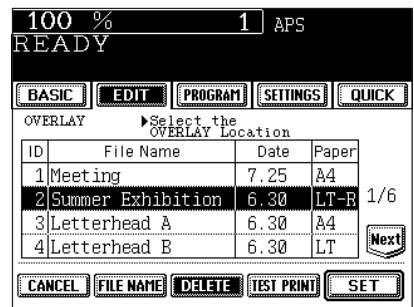

## 14. OVERLAY (Cont.)

### Overlaying Originals with Stored Image

- 1 Place paper in the drawer(s). ► Page 2-4
- 2 Place the original(s). ► Page 2-9
- 3 Press the **EDIT** key to enter the edit menu, and press the **OVERLAY** key.
  - If the desired function keys are not displayed, press the **Next** key to change the menu screen.

- 4 Press the **OVERLAY** key.

- 5 Press the file name you desire ( the selected file name will be shaded), and press the **SET** key.
  - Select other copy modes as required.

- 6 Press the **START** key.

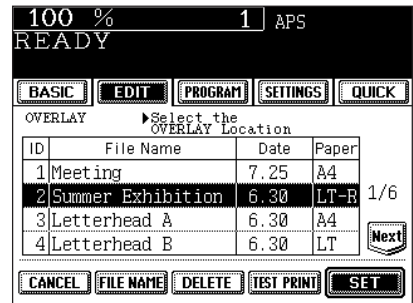
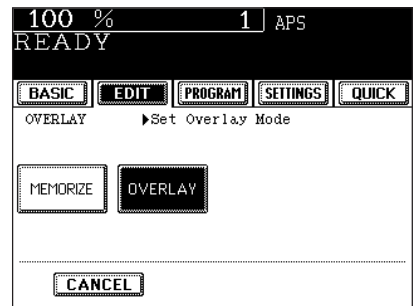
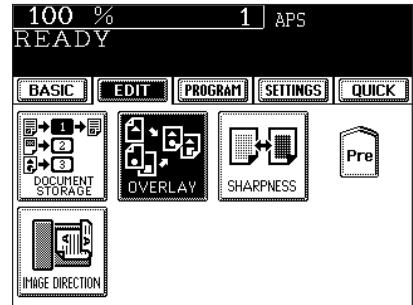

### Confirming Overlay (Test Print)

When overlaying more than one original with the stored image, the first original is overlaid with the stored image and printed out.

- 1 Perform the above step 1 to step 4.
- 2 Press the file name you desire (the selected file name will be shaded), and press the **TEST PRINT** key.

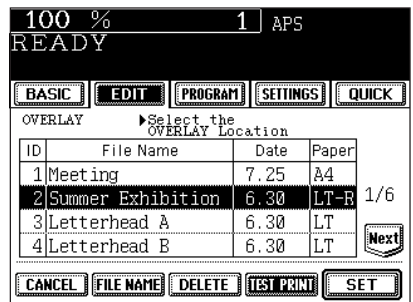



# 15. SHARPNESS ADJUSTMENT

This function allows you to emphasize the letters and edges of images.

- 1** Place paper in the drawer(s). ► Page 2-4
- 2** Place the original(s). ► Page 2-9
- 3** Press the **EDIT** key to enter the edit menu, and press the **SHARPNESS** key.
  - If the desired function keys are not displayed, press the **Next** key to change the menu screen.

- 4** Press the **SOFT** ( or **SHARP** ) key.
  - Pressing the **SOFT** key suppresses the moire fringe while pressing the **SHARP** key emphasizes the letters and sharpens the fine lines.

- 5** Press the **SET** key.
  - Select other copy modes as required.

- 6** Press the **START** key.

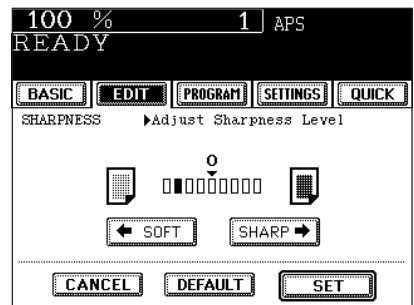
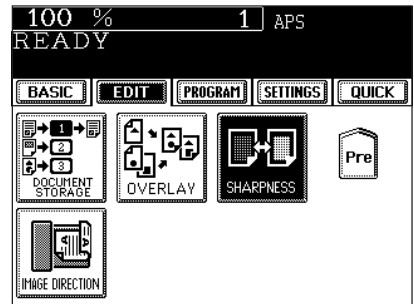

## Canceling the Sharpness Adjustment

Press the **DEFAULT** key, then the **SET** key.

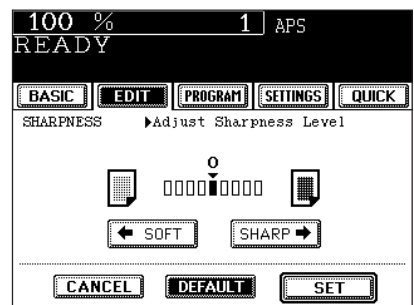

# 16. DIRECTION OF DUPLEX COPY IMAGES (Rotation)

When lengthwise LD, A3, A5 or B4 paper is copied under the mode of 1-Sided Originals to 2-Sided Copies, 2-Sided Originals to 1-Sided Copies, this function allows you to adjust the direction for 'side-by-side' opening.

\* This function is not necessary for copying in the direction of 'vertical' opening.

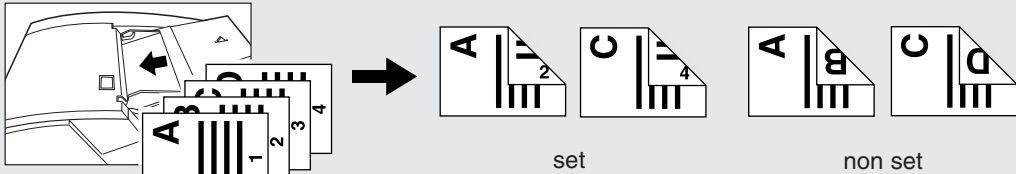

4

- 1 Place paper in the drawer(s). ▶ Page 2-4
- 2 Place the original(s). ▶ Page 2-9
- 3 Select 1-Sided Originals to 2-Sided Copies (or 2-Sided Originals to 1-Sided Copies).
  - Duplex copying ▶ Page 3-8
- 4 Press the **EDIT** key to enter the editing menu, and press the **IMAGE DIRECTION** key.
  - If the desired function keys are not displayed, press the **Next** key to change the menu screen.

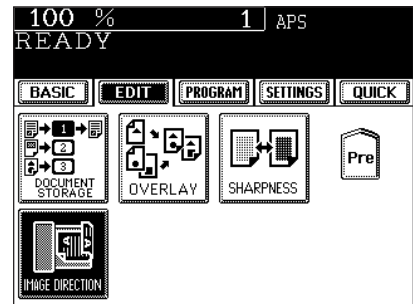

- 5 Press the **SET** key.

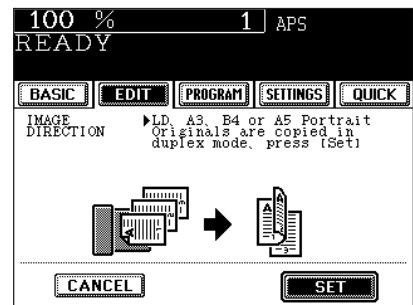

● Select other copy modes as required.

- 6 Press the **START** key.

# 5. USING THE SPECIAL FUNCTIONS

1. Continuous original feeding / Single original feeding .....	5-2
2. Mixed-sized originals .....	5-4
3. Job memory .....	5-5
4. Bypass copying .....	5-8
- Bypass copying on standard size paper .....	5-10
- Bypass copying on non-standard size paper .....	5-11
5. Weekly timer .....	5-13
6. Setting the “OTHER” size key .....	5-14
7. Setting the date and time .....	5-15
8. Setting the automatic energy save mode .....	5-16
9. Setting the automatic off-mode .....	5-17
10. Switching languages .....	5-18
11. Account Numbers .....	5-19
12. Entering letters .....	5-28

# 1. CONTINUOUS ORIGINAL FEEDING / SINGLE ORIGINAL FEEDING

When using the reversing automatic document feeder, you can select the continuous feed mode (default setting) where multiple (or single) originals are continuously fed in one by one, or the single-feed mode where if you insert an original, it is automatically pulled in and starts being copied.

## Continuous Feed Mode

- 1 Place paper in the drawer(s). ► Page 2-4
- 2 Place the original(s) on the reversing automatic document feeder. ► Page 2-11  
- Originals can be set maximum 100 sheets at a time.
- 3 Press the **PROGRAM** key to enter the program menu, and press the **ADF** key.

5

- 4 Press the **ADF** key.

- Select other copy modes as required.

- 5 Press the **START** key.

### Tip

When the number of originals is too large to be set at one time, you can divide the originals into two to ten sets and set them one after another. To do so, place the first set of originals first, and press the **CONTINUE** key while the scanning is in progress. After they have been scanned, place the previous set of originals.

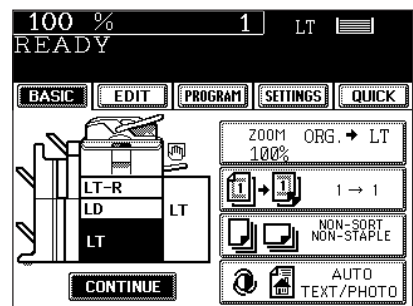
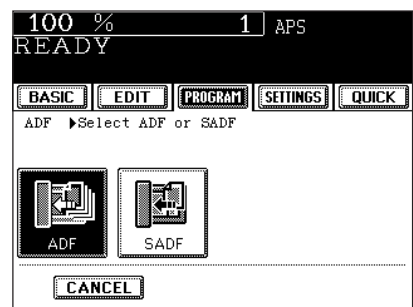
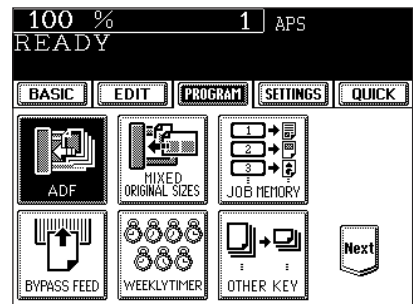

## Single-feed Mode

- 1 Place paper in the drawer(s). ► Page 2-4
- 2 Press the **PROGRAM** key to enter the program menu, and press the **ADF** key.

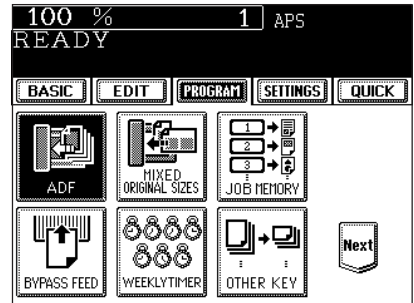

- 3 Press the **SADF** key.
  - Select other copy modes as required.

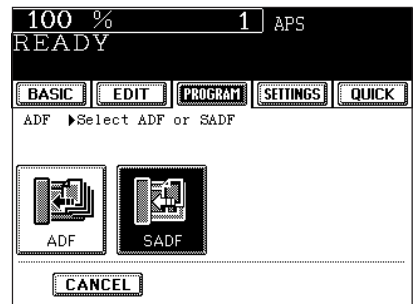

- 4 Place an original. ► Page 2-9
  - The original is automatically pulled in and the screen changes as shown on the right.
  - If there are more originals, set them in the same way. (The same operation is carried out whether or not you press the **YES** key.)

- 5 After all originals have been fed through the reversing automatic document feeder, press the **FINISHED** key.
  - Copying begins.

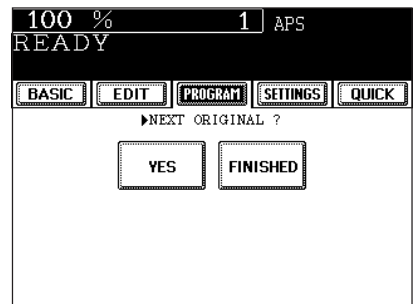

## 2. MIXED-SIZED ORIGINALS

When placing the different-sized originals in the reversing automatic document feeder, you can make copies by setting MIXED-SIZED ORIGINALS.

The available combination of mixed-sized originals are as follows:

- LD, LG, LT, LT-R      - A3, A4, A4-R, B4, B5

\* The image may be copied out of position depending on the combination.

**1** Place paper in the drawer(s). ▶ Page 2-4  
- Bypass copying is not possible.

**2** Adjust the slide to the widest paper size, and align the originals against the left front side.  
- Place the originals face up.

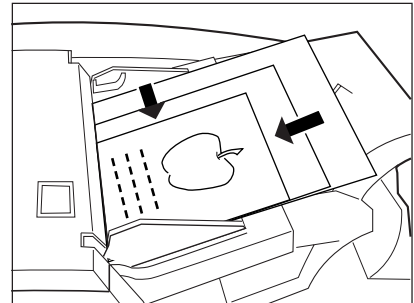

**3** Press the **PROGRAM** key to enter the program menu, and press the **MIXED ORIGINAL SIZES** key.

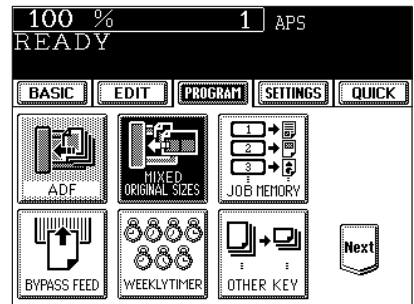

**4** Press the **SET** key.

**5** Select either the Automatic Paper Selection (▶ Page 3-2) or Automatic Magnification Selection mode (▶ Page 3-4).  
- To make duplexed copies, select the automatic magnification mode.



● Select other copy modes as required.

**6** Press the **START** key.

# 3. JOB MEMORY

You can store and recall a combination of frequently used copy jobs at anytime. Up to four such combinations of jobs can be stored.

\* You cannot delete the copy modes that have already been stored in the memory, but you can rewrite new jobs on the memory key in which some copy modes have already been stored.

## Storing a Combination of Copy Job Settings

### 1 Select the desired copy modes.

Example :  
Reproduction ratio ..... 85%  
Copy quantity ..... 10 copies  
Paper size ..... LT-R

### 2 Press the PROGRAM key to enter the program menu, and press the JOB MEMORY key.

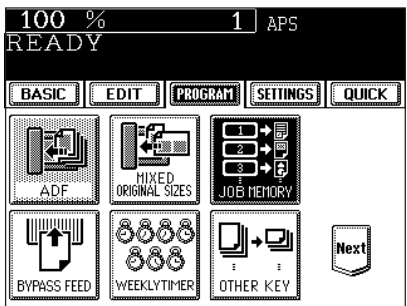

### 3 Press the MEMORY key.

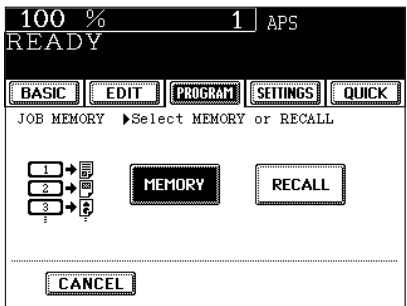

### 4 Press the desired Memory Number key.

- The copy job settings are stored in the selected Memory Number key.

#### Tips

- Memory Number keys where copy jobs have been already stored are shown in a half-tone shaded pattern.
- The stored copy jobs remain unchanged until different copy jobs are entered. (They are retained even after the power switch is turned off.)

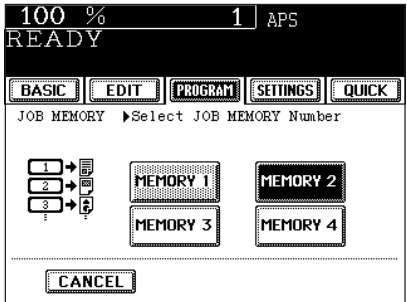

### 3. JOB MEMORY (Cont.)

#### Recalling a Stored Combination of Copy Job Settings to Make Copies

- 1 Place paper in the drawer(s). ▶ Page 2-4
- 2 Place the original(s). ▶ Page 2-9
- 3 Press the **PROGRAM** key to enter the program menu, and press the **JOB MEMORY** key.

5

- 4 Press the **RECALL** key.

- 5 Press the Memory Number key where the desired combination of copy job settings are stored.
  - Memory Number keys where copy jobs have been already stored are shown in a half-tone shaded pattern.

- 6 Press the **START** key.
  - Copies will be made in the recalled copy jobs.

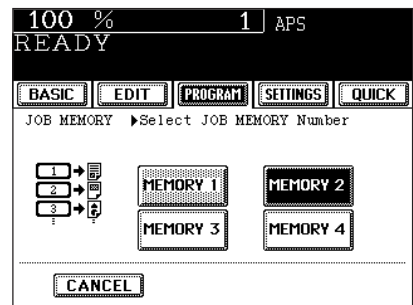
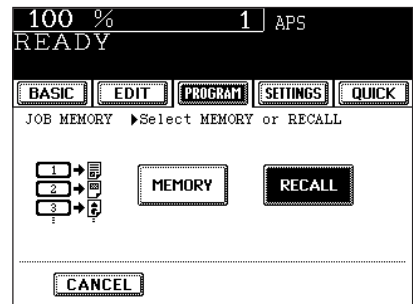
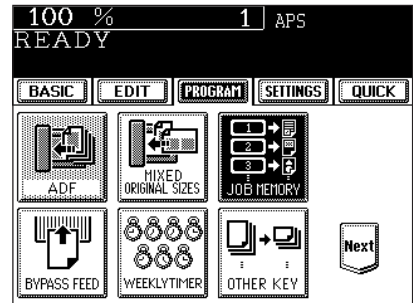



## Confirming Stored Copy Jobs

To confirm the copy modes stored in the Memory Number key, perform steps 3 to 5 on the previous page, then press the **SETTINGS** key.

- The screen on the right is an example of jobs that have been stored in "MEMORY 2".

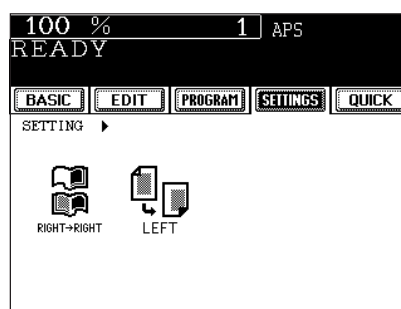
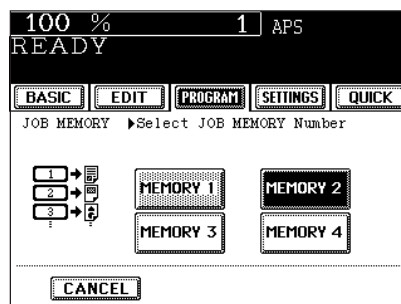

## 4. BYPASS COPYING

When you want to make copies on thick paper, OHP film, tab paper, tracing paper, sticker labels, use the sheet bypass. (Only thick and tab papers can be set in the drawer. ► Page 2-7)

If the desired size of paper (standard size) is not set in any of the drawers, or if you want to make copies on non-standard size, make bypass copies.

The modes below are available even in bypass copying if the paper size is specified:

- automatic magnification selection
- duplex
- binding margin
- edge erase
- dual-page
- 2 IN 1 / 4 IN 1
- trimming/masking
- mirror image
- staple sort
- magazine sort
- saddle stitch
- hole punch

In these cases, the setting procedures of the following two sizes of paper are different.

- Bypass copying on standard size ► Page 5-10
- Bypass copying on non-standard size ► Page 5-11

\* When copying is finished, the lamp of the **//CLEAR ALL** key lights. Either press the **//CLEAR ALL** key or wait 45 seconds before the bypass copying mode automatically returns to the default mode.

\* The copier stops its operation when the paper set on the bypass guide has run out even if there is the same size of copy paper in the drawer. The copier starts again when adding the paper on the bypass guide before the automatic clear all mode works.

5

### Bypass copying

The general procedure for making bypass copies (the paper size is not specified) is described below.

\* In this case, the paper exits with its copied side up.

#### 1 Set sheets of paper on the bypass guide and align the slides with the size of the paper.

- This message appears:

Ready for bypass feeding

- Acceptable paper type for bypass copy ► Page 2-4
- Place the paper with the side to be copied facing up.
- If you put several sheets on the bypass guide at a time, fan the papers well before placing it.
- Place the paper so as not to exceed the line indicated on the slide.
- Do not push the paper forcibly into the entrance of bypass feeding. It may cause paper jam.
- Draw the triple paper holder depending on the paper size.

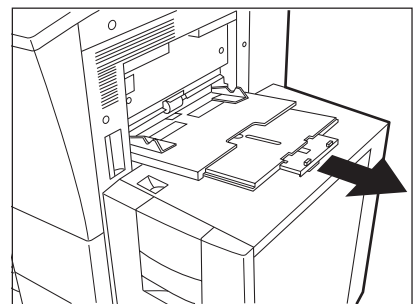
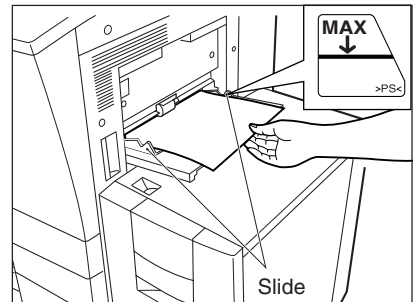

**2** Place the original(s). ▶ Page 2-9

**3** If the paper other than standard type has been set, press the **PROGRAM** key to enter the program menu, and press **BYPASS FEED** key.

- If the standard size paper has been set, you do not have to perform steps 3 to 4.

- If you press the **MEDIA TYPE** key on the right menu, which is displayed when placing paper on the bypass guide, the menu of step 4 is also displayed.

**4** After selecting the paper type corresponding to the type of the paper that has been set, press the **SET** key.

- When selecting OHP film, the hole punch mode and the staple mode cannot be used.

**Tip**

If you select the paper type not corresponding to the type of the paper that has been set, it may cause a problem such as a paper jam, significant image deterioration, etc.

● Select other copy modes as required.

**5** Press the **START** key.

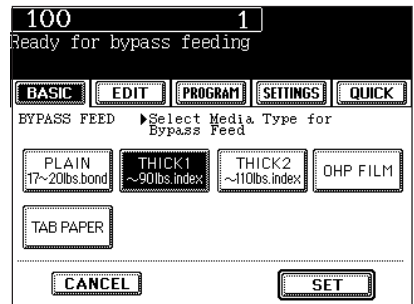
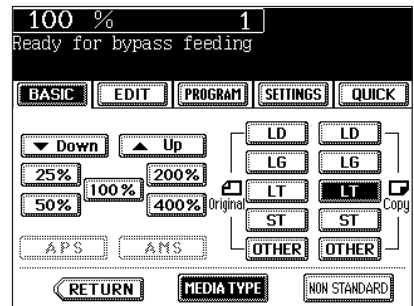
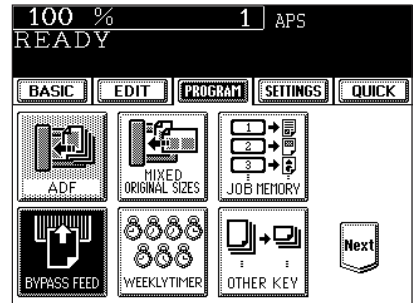

## 4. BYPASS COPYING(cont.)

### Bypass Copying on Standard Size Paper

- 1 perform steps 1 to 2 on pages 5-8, 5-9.  
-Set the "OTHER" size key as necessary. ▶ Page 5-14

#### Tip

If the paper that has been set is a standard size other than LD, LG, LT or ST, you will select the (OTHER) key in step 2. In this case, you need to make the (OTHER) key recognize the same size as the paper that has been set.

- 2 Press the key of the same type as the paper that has been set.

-Non-standard size paper ▶ Page 5-12

5

- 3 If you set the paper other than plain paper, press the (MEDIA TYPE) key.

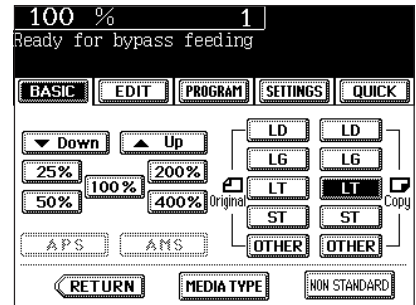

- 4 After selecting the media type key corresponding to the type of the paper that has been set, press the (SET) key.

#### Tip

If you select the media type key not corresponding to the type of the paper that has been set, it may cause a problem such as a paper jam, significant image deterioration and etc.

- Select other copy jobs as required.

- 5 Press the (START) key.

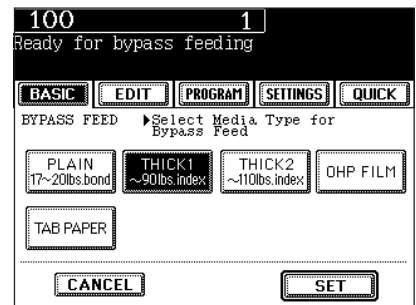
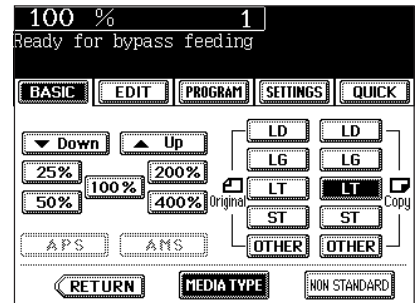

## Bypass Copying on Non-Standard Size Paper

The size of non-standard paper is within the following ranges:

Length: 100 - 297mm (3.94" - 11.69")    Width: 148 - 432mm (5.83" - 17.01")

**1** Perform steps 1 to 3 on page 5-10.

**2** Press the **NON-STANDARD** key.

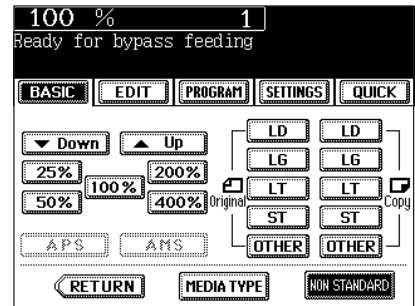

**3** Key in each dimension (length and width), or recall the data stored in the MEMORY. Then press the lower **SET** key.

- When using the digital keys to key in the size:  
Key in the length and press the upper **SET** key. Similarly, set the value for the width.

- Press the **MEMORY 1** (or **MEMORY 2**, **MEMORY 3**, **MEMORY 4**) key and the paper size memorized in the MEMORY 1 appears.

- Storing a non-standard size in the memory ► Page 5-12

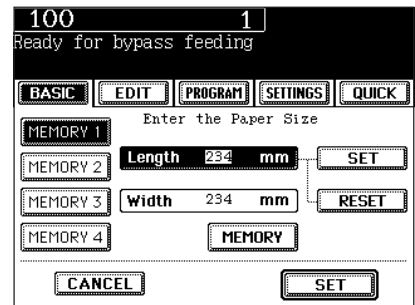
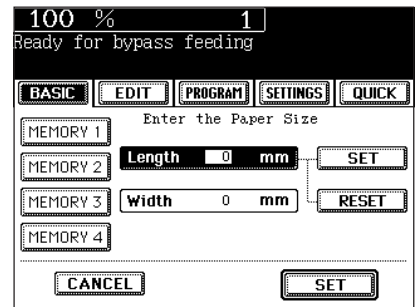

\* 25.4mm = 1"

● Select other copy jobs as required.

**4** Press the **START** key.

## 4. BYPASS COPYING(cont.)

### Bypass Copying on Non-Standard Size Paper(cont.)

#### Storing a Non-Standard Size in the MEMORY

It is convenient if a frequently used non-standard size of paper is stored in the memory.

**1** Perform steps 1 to 3 on page 5-10.

**2** Press the **NON-STANDARD** key.

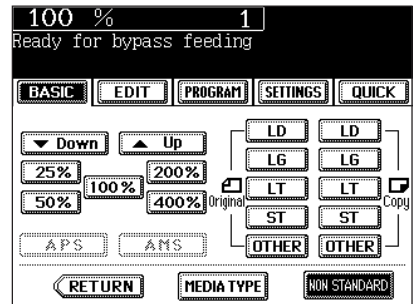

**5**

**3** Press the desired Memory Number key.

- When the paper size is '0mm', the selected Memory Number key is vacant.

- When the paper size is displayed, a non-standard size is already stored in the selected Memory Number key. To delete the settings, perform step 4. New settings will be rewritten and stored on that Memory Number key.

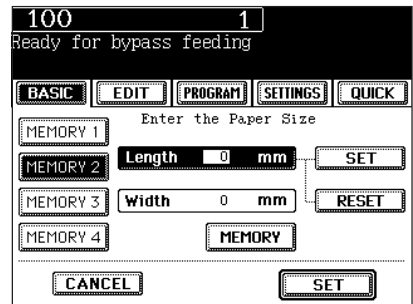

**4** Key in each dimension, then press the **MEMORY** key.

- Key in the length and press the upper **SET** key. Similarly, set the value for the width.

- The paper size is stored in the shaded Memory Number key.

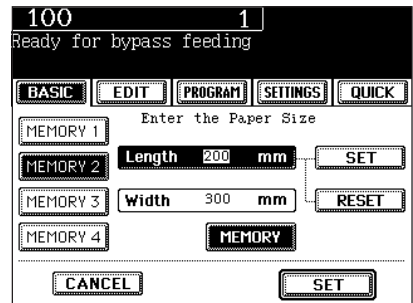

# 5. WEEKLY TIMER

Using the built-in weekly timer, you can have the copier automatically turned ON and OFF at specified times. For instance, you can set the timer for the starting time and closing time of your office so that the copier will automatically turn itself ON and OFF at those specified times.

- The ON/OFF times of the weekly timer are retained until they are changed. When the weekly timer is resumed, the previous settings will again become effective.
- When the weekly timer is in use, the timer lamp on the control panel lights.
- \* When the power switch is turned off, the weekly timer does not work.

## 1 Press the **PROGRAM** key to enter the program menu, and press the **WEEKLY TIMER** key.

- The **WEEKLY TIMER** key is half-tone shaded when the weekly timer has already been set.

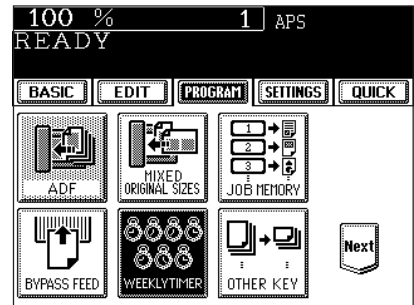

## 2 Check the settings on the display, and if corrections are necessary, press the **CHANGE** key.

- If no correction is needed, press the **SET** key.

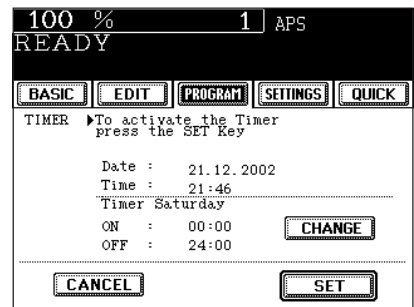

## 3 Set the ON/OFF times for each day of the week.

- Use the **← SUN** and **SAT →** keys to switch the days of the week.
- Key in numbers using the digital keys. After entering each number, press the upper **SET** key.
- After setting the times for all the days of week, press the lower **SET** key. The **WEEKLY TIMER** key becomes half-tone shaded.

### Tip

For holidays when the copier is not turned on, key in the same times for both ON and OFF, eg. ON:00:00 and OFF:00:00.

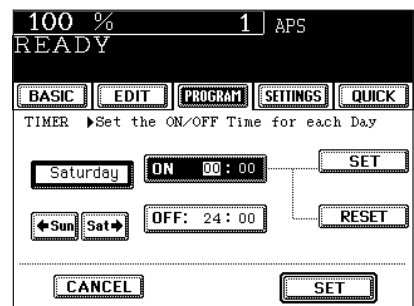

### Copying when the power is off

The copier can be used if you press **START** key.

- If you leave the copier for a while after the copy is finished, it will automatically return to OFF-mode by the weekly timer.

# 6. SETTING THE “OTHER” SIZE KEY

When original or paper size is required to be specified and you need to specify it to 'OTHER' size (except for non-standard size), this function should be used.

- This function allows the (OTHER) key on the screen on the right to recognize the size that will be used. The initial setting for this key is COMP.

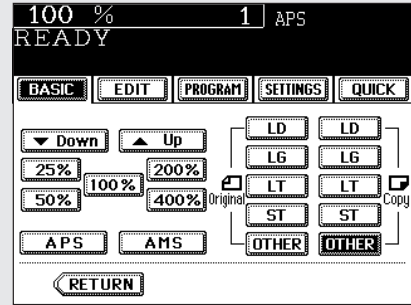

**1** Press the (PROGRAM) key to enter the program menu, and press the (OTHER KEY) key.

5

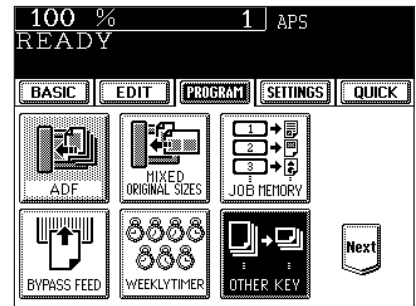

**2** Press the PAPER SIZE key of the paper corresponding to the size that will be used.

- Setting has been completed.

**Tip**

If you select 'A4' in step 2 for instance, the (OTHER) keys (both ORIGINAL and PAPER SIZE keys) are recognized as A4 size.

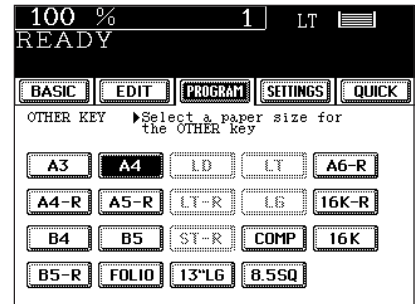



# 7. SETTING THE DATE AND TIME

The clock built in to the copier can be set by entering the date, day of the week and time using the digital keys. Also, you can easily change the clock to and from the daylight saving time system at the touch of a key.

## 1 Press the **PROGRAM** key to enter the program menu, and press the **DATE/TIME** key.

- If the desired function keys are not displayed, press the **Next** key to change the menu screen.

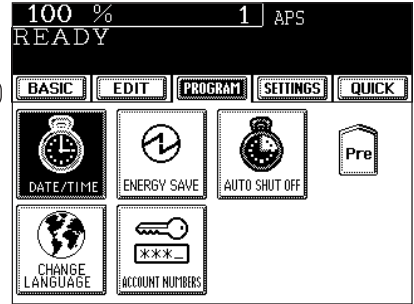

## 2 Key in the year (last two digits only), month, date, day of the week, time (24-hour format) and minutes, in this order from the left-hand column.

- Press the **Next** key to move to the next entry column.

Example: To enter 2002 / November .....

0 → 2 → **Next** → 1 → 1 → **Next** → .....

\* Numbers corresponding to the days of week:

Number	1	2	3	4	5	6	7
Day of week	Sun.	Mon.	Tue.	Wed.	Thu.	Fri.	Sat.

## 3 Check that the settings are all correct.

- If any of the settings are incorrect, press the **Back** key to return and correct it.

## 4 Press the **SET** key.

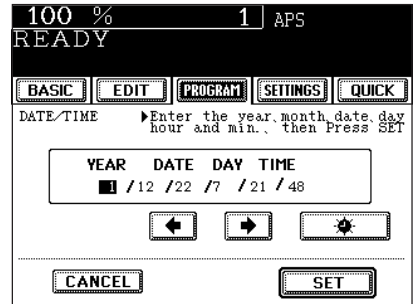

### Tip

#### ● Setting the Clock for Daylight Saving Time

- Press the **Daylight Saving** key to shade it on the first day of summer, then press the **SET** key.
- If the time was 13:40 before setting the daylight saving time system, for example, it becomes 14:40 when the icon is shaded.

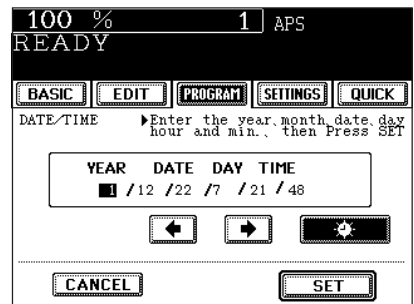

# 8. SETTING THE AUTOMATIC ENERGY SAVE MODE

This function allows the copier automatically to go into the energy saving mode (unnecessary electricity is cut off at standby) if it is left inactive for a certain period of time.

-  ENERGY SAVER key ▶ Page 1-5

**1** Press the **PROGRAM** key to enter the program menu, and press the **ENERGY SAVE** key.

- If the desired function keys are not displayed, press the **Next** key to change the menu screen.

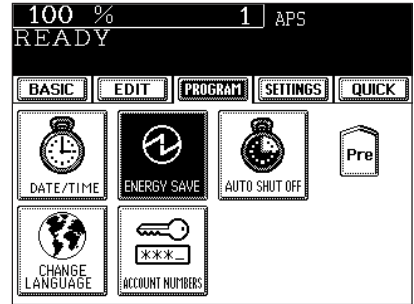



**5**

**2** Select the period of time (in minutes) on the display allowed before the Automatic Energy Saving mode is activated.

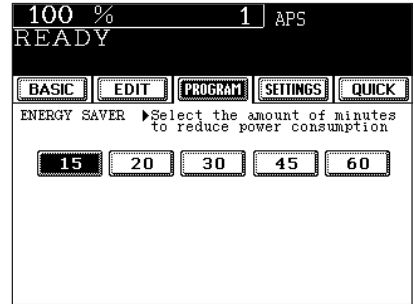
- The setting procedure finishes and the display returns to the program menu screen.  
- The default setting is '15 minutes'.



## Clearing the Automatic Energy Saving Mode

Press the  ENERGY SAVER or  START key on the control panel. The copier starts to warm itself up.

# 9. SETTING THE AUTOMATIC OFF-MODE

When the power of the optional printer controller is ON, the copier goes into the sleep mode which stands by with the minimum power consumption.

**1** Press the **PROGRAM** key to enter the program menu, and press the **AUTO SHUT OFF** key.

- If the desired function keys are not displayed, press the **Next** key to change the menu screen.

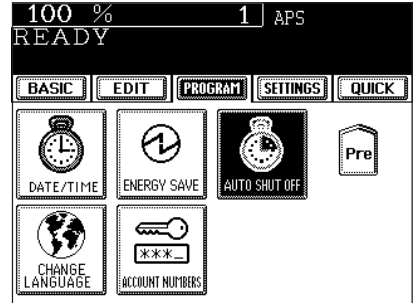

**2** Select the period of time (in minutes) on the display allowed before the Off-mode (the Sleep mode if the power is being supplied to the optional printer controller) is activated.

- The setting procedure finishes and the display returns to the program menu screen.
- The default setting is '90 minutes'.

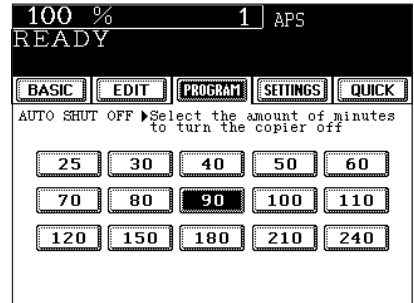

5

## Clearing the Off-Mode/Sleep Mode

Turn ON the power switch once again when the copier is in the off-mode. Press the **START** key during the sleep mode. The copier starts to warm itself up.

# 10. SWITCHING LANGUAGES

The language used on the touch panel can be changed to a different one.

**1** Press the **PROGRAM** key to enter the program menu, and press the **CHANGE LANGUAGES** key.

- If the desired function keys are not displayed, press the **Next** key to change the menu screen.

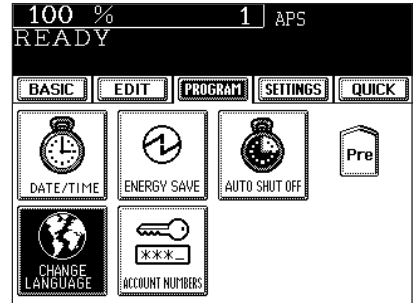

**2** Press the key of the desired language.

5

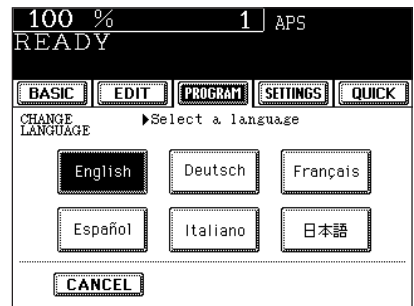

# 11. ACCOUNT NUMBERS

You can administer the copy quantity of each group by setting a account number for each purpose (copier and printer ). Up to 150 numbers can be set.

\*You need a master number to be registered when you use this function for the first time.

## Master number registration

**1** Press the **PROGRAM** key to enter the program menu, and press the **ACCOUNT NUMBERS** key.

- If the desired function keys are not displayed, press the **Next** key to change the menu screen.

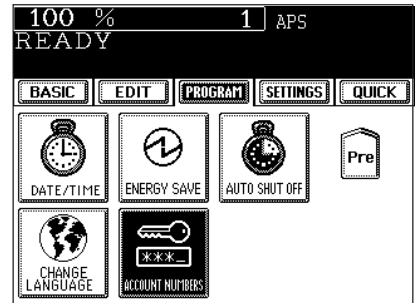

**2** Press the **SET ACCOUNT NUMBERS** key in the account number menu.

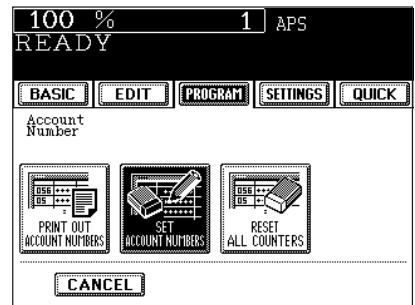

**3** Press the **ENABLE** key, then **SET** key.

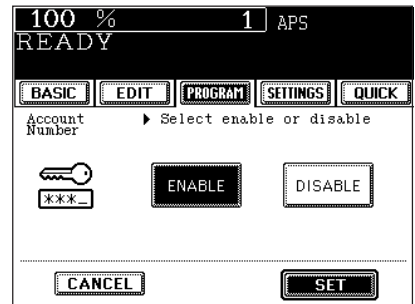

**4** Press the **SET** key.

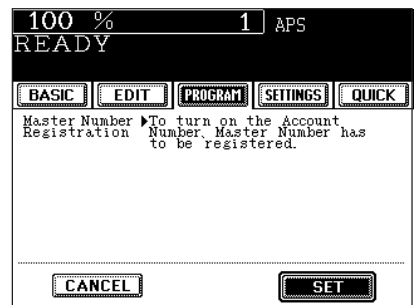

## 11. ACCOUNT NUMBERS (Cont.)

**5** Input the master number name, and press the **(SET)** key.

- Entering letters ► Page 5-28

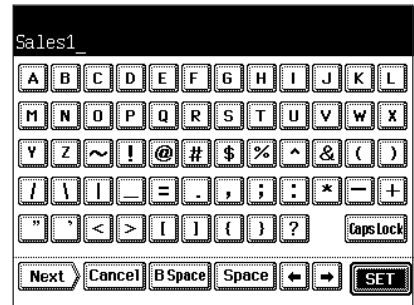

**6** Key in the desired master number (the same number) both for “NEW NUMBER” and for “RETYPE THE NEW NUMBER”, and press the **(SET)** key.

- The master number is 5 digits (“00000” is invalid).

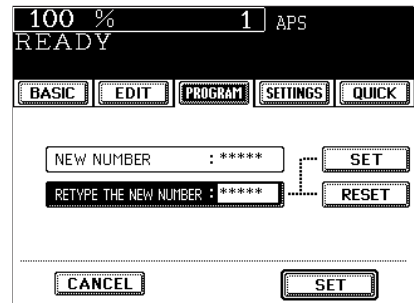

**7** Master number name is displayed in the account “001”.

- Master number registration is completed.

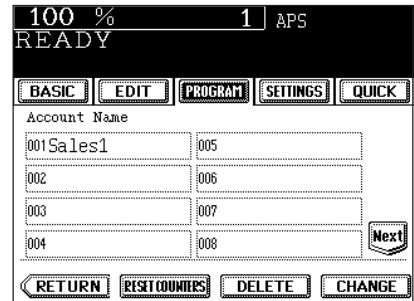

### Procedure to display the account number menu

**1** Press the **(PROGRAM)** key to enter the program menu. Then, press the **(ACCOUNT NUMBERS)** key.

- If the desired function keys are not displayed, press the **(Next)** key to change the menu screen.

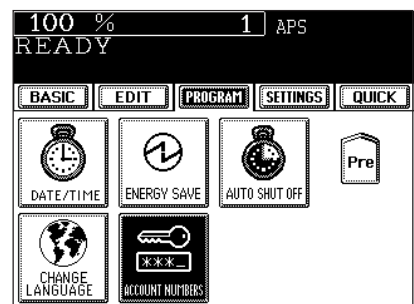

## 2 Key in the master number or the account number (5 digits), then press **SET** key.

- Registration of Account Number ▶ As shown below

### Tip

Input the master number for using “SET ACCOUNT NUMBERS” and “RESET ALL COUNTERS”.

## 3 The account number menu is displayed.

- The screen when the master number is entered

- The screen when the account number is entered

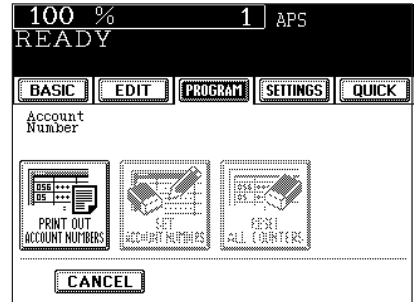
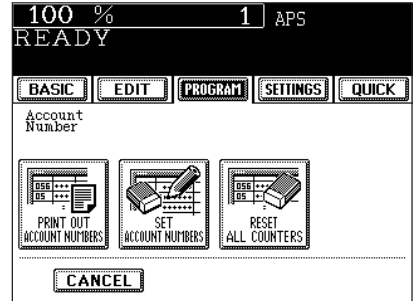
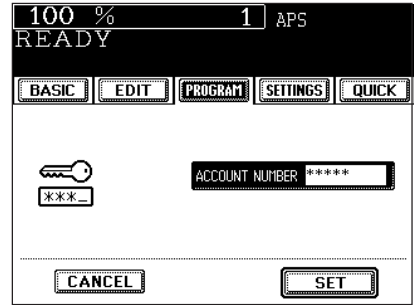

### Registration / Change / Deletion of Account Number

\*Available only when the master number is entered.

### Registering a New Account Number

## 1 Press the **SET ACCOUNT NUMBERS** key in the account number menu.

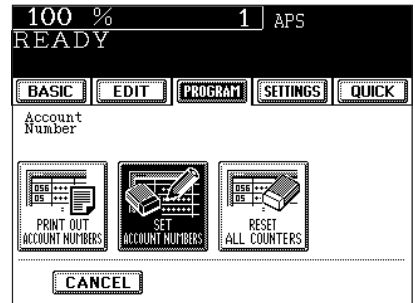

# 11. ACCOUNT NUMBERS (Cont.)

**2** Press the **ENABLE** key, then **SET** key.

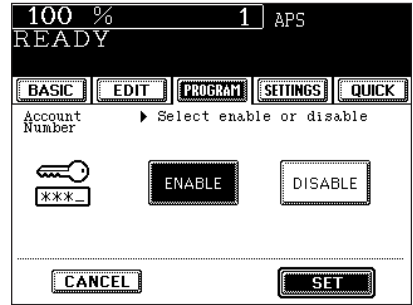

**3** Press the account number where you want to register the account number, and press the **CHANGE** key.

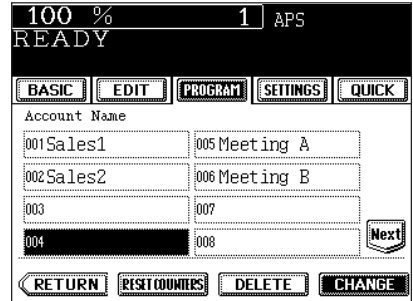

5

**4** Input the account name and press the **SET** key.  
- Entering letters ► Page 5-28

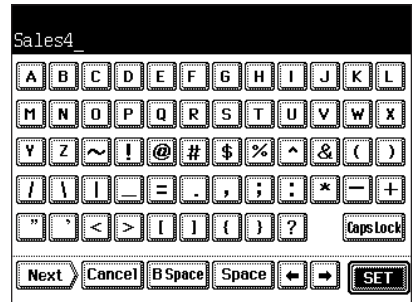

**5** Key in the desired account number (the same number) both for “NEW NUMBER” and for “RETYPE THE NEW NUMBER”, and press the lower **SET** key.

- The account number is 5 digits (“00000” is invalid).
- Registering of the account number is completed.

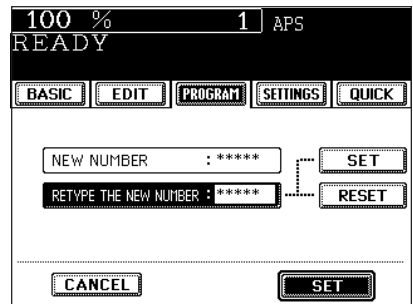



## Changing a Specific Account Number

**1** Press the **SET ACCOUNT NUMBERS** key in the account menu.

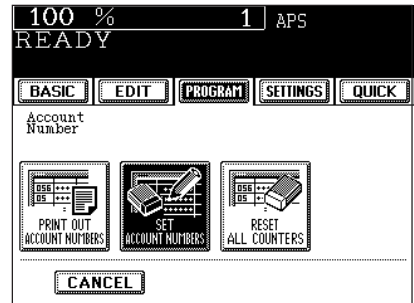

**2** Press the **ENABLE** key, then **SET** key.

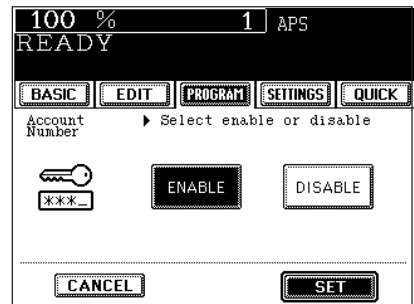

**3** Press the account number where you want to change the account number, and press **CHANGE** key.

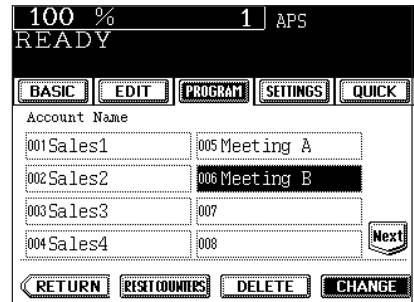

**4** Press the **SET** key.

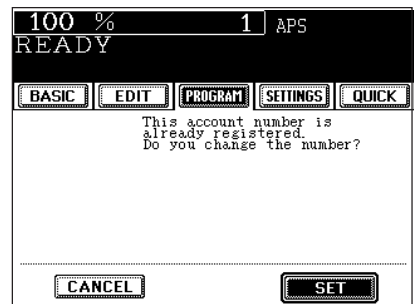

# 11. ACCOUNT NUMBERS (Cont.)

**5** Input the account name you want to register, and press the **(SET)** key.

- Entering letters ► Page 5-28

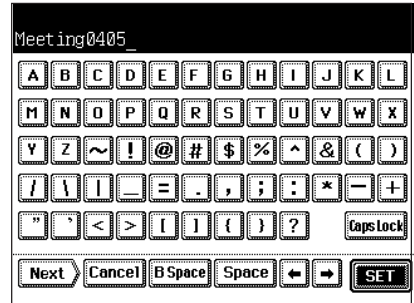

**6** Key in the former account number for “CURRENT NUMBER” and the new account number both for “NEW NUMBER” and “RETYPE THE NEW NUMBER”, and press the lower **(SET)** key.

- The master number is 5 digits (“00000” is invalid).
- Changing of the account number is completed.

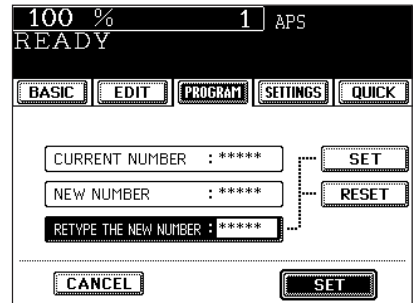

5

## Deleting a Specific Account Number

**1** Press the **(SET ACCOUNT NUMBERS)** key in the account menu.

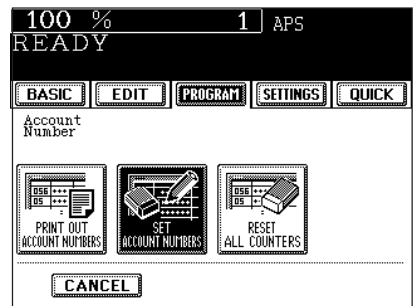

**2** Press the **(ENABLE)** key, then the **(SET)** key.

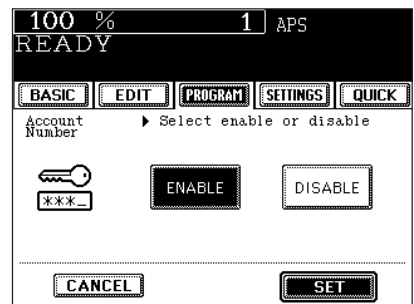

**3** Press the account number where you want to delete the account number, and press the **DELETE** key.

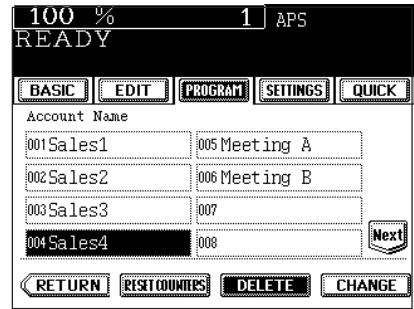

**4** Press the **YES** key.  
- Deleting of the selected account number is completed.

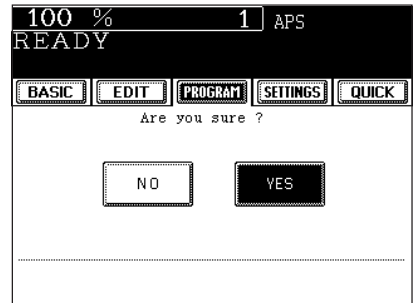

5

### Clearing a Specific Account Counter

**1** Press the **SET ACCOUNT NUMBERS** key in the account number menu.

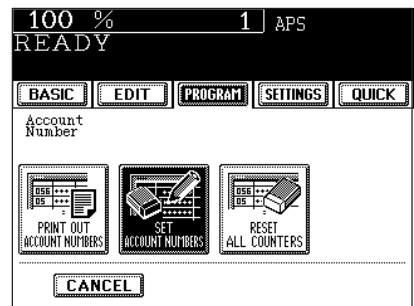

**2** Press the **ENABLE** key, then the **SET** key.

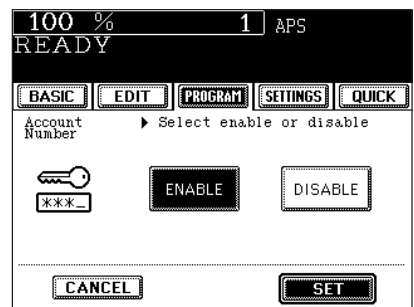

# 11. ACCOUNT NUMBERS (Cont.)

**3** Press the account number you want to clear the counter, and press the **RESET COUNTERS** key.

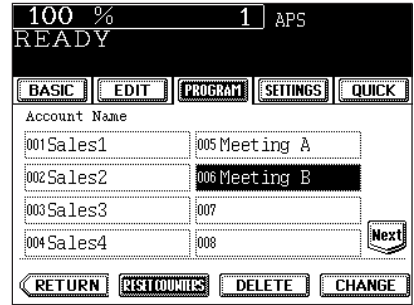

**4** Press the **YES** key.  
- The counter reset is completed.

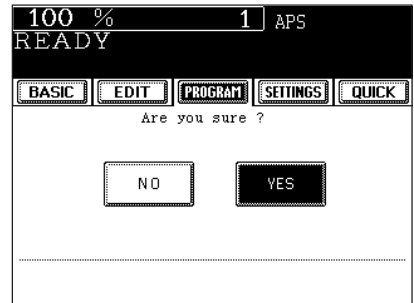

## Disabling a Account Number

**1** Press the **SET ACCOUNT NUMBERS** key in the account number menu.

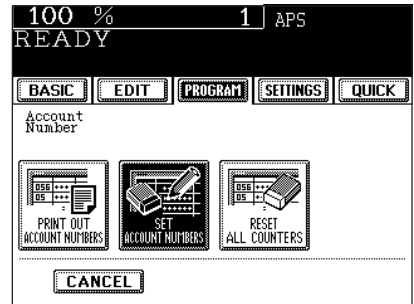

**2** Press the **DISABLE** key, then the **SET** key.  
- Disabling set is completed.

**Tip**

If you want to enable the account number function, you have to input the master number again.

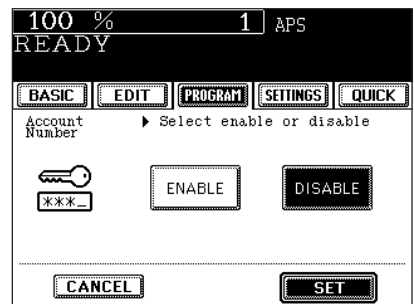

## Print out account number

\*This function prints out the number of copies output for each account.

- 1 Press the **PRINT OUT ACCOUNT NUMBERS** key in the account number menu.

- Printing starts.

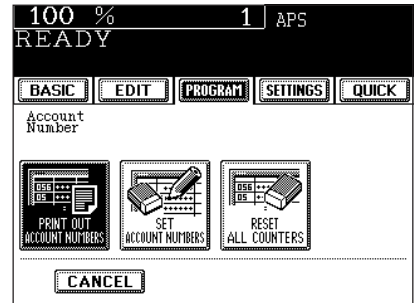

## Clearing All Counters

This function clears all counters to "000000".

\*Available only when the master number is entered.

\*The total counter (▶ Page 1-4) cannot be reset.

- 1 Press the **RESET ALL COUNTERS** key in the account number menu.

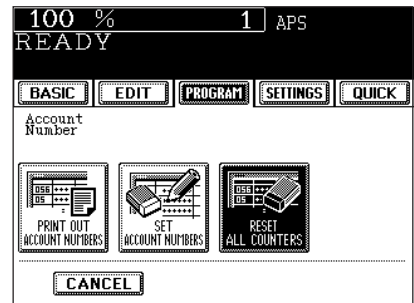

- 2 Press the **YES** key.  
- The counter is reset to "000000".

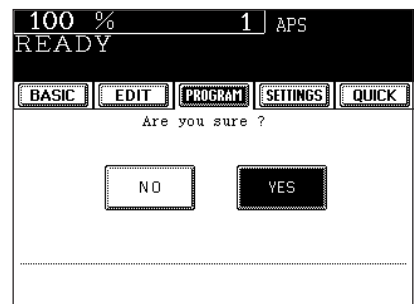

# 12. ENTERING LETTERS

The following screen is provided for entering letters.  
\* To enter numbers, use the digital keys on the control panel.

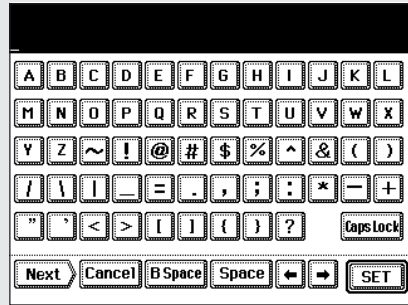

The following keys are used to enter letters.

- **CapsLock**..... Press this key to switch capital letters and small letters.
- **B Space**..... Press this key to delete the letter before the cursor.
- **Space**..... Press this key to enter a space.
- **← →**..... Press these keys to move the cursor.
- **SET**..... Press this key to fix all entered letters.
- **Cancel**..... Press this key to cancel entry of letters.

5

## Entering Letters

Example: Enter "Meeting"

**1** Press the **CapsLock** key to enter capital letters, then press the **(M)** key in the Letter Entry Screen.

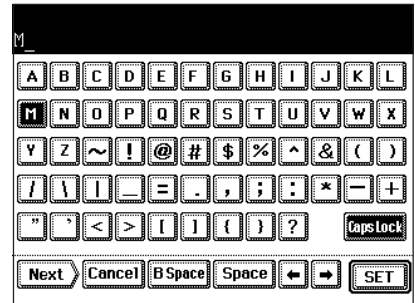

**2** Press the **CapsLock** key to enter small letters, then press the **(E)** key.

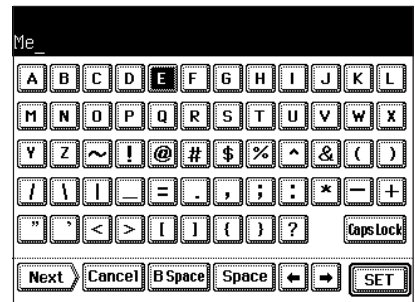

**3** Press the **(E)**, **(T)**, **(I)**, **(N)** and **(G)** keys.

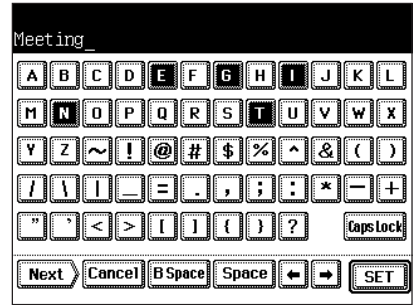

**4** Press the **(SET)** key to fix the entered letters.

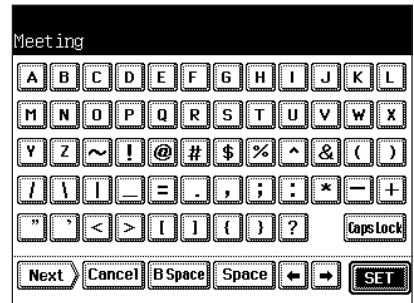

### Correcting Entered Letters

Example: Correct "Meeting" to "MEETING".

**1** Press the **(B Space)** key to delete "eeting".

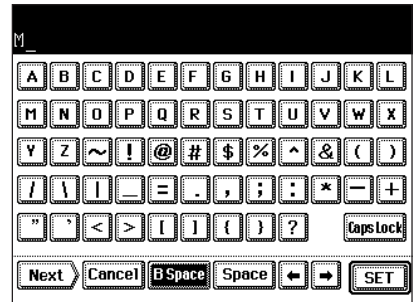

**2** Press the **(CapsLock)** key to enter the capital letters.

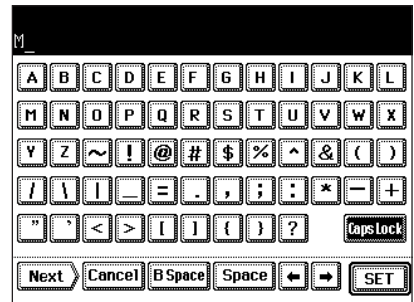

## 12. ENTERING LETTERS (Cont.)

**3** Press the **E**, **E**, **T**, **I**, **M** and **G** keys.

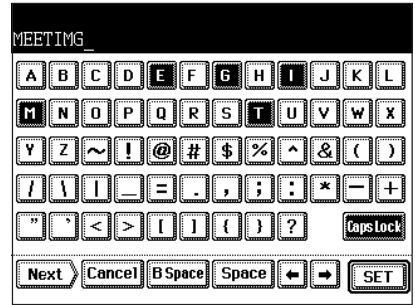

**4** Press the **←** key to move the cursor to (under) "G".

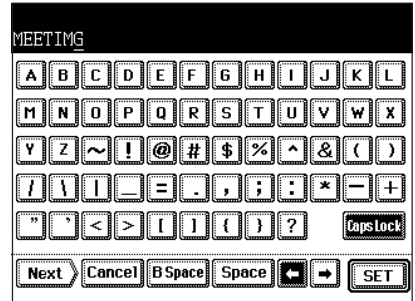

**5**

**5** Press the **B Space** key to delete "M".

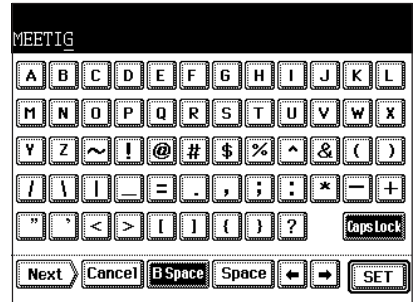

**6** Press the **N** key to enter "N", then the **SET** key to fix the entered characters.

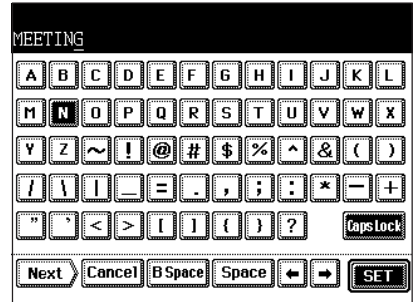



# 6. SELECTING FINISHING MODES

## (USING THE OPTIONAL FINISHERS AND INSERTER)

1. Finishing modes and finishers (optional) .....	6-2
2. Sort/group copying .....	6-3
3. Staple sorting (optional) .....	6-4
4. Magazine sort & saddle stitch mode (booklet mode) (optional) .	6-6
5. Hole punch mode (optional) .....	6-8
6. Inserter mode (optional) .....	6-9
- Setting the inserter .....	6-10
- Using only staple and hole punch .....	6-13

# 1. FINISHING MODES AND FINISHERS (OPTIONAL)

There are 2 types of optional finishers ( AR-F11 and AR-F12 ). Functions available differ depending on whether a finisher is installed and which type of finisher it is.

- Press the key on the basic screen on the right (shaded), and confirm the finishing modes on the panel.
- \* The touch panel used in this chapter appears when the optional saddle stitch finisher (AR-F12, with hole punch unit) and inserter are installed with your copier.

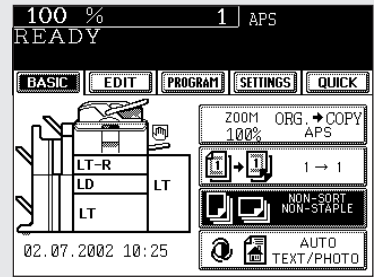

## Names of the Main Components

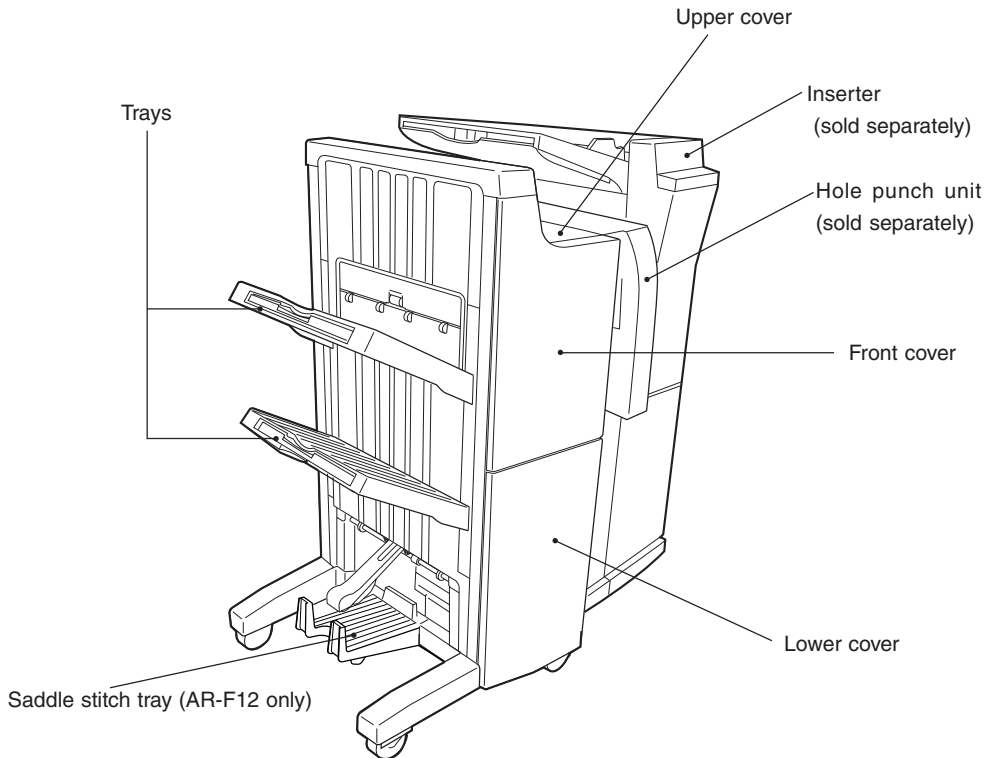

### Tip

When the finisher trays reach their maximum loading capacity (► Page 9-4), the following message appears:

Remove paper from the finisher

Remove the copies from the trays and the copier automatically resumes making copies.

## 2. SORT/GROUP COPYING

To make multiple copies, you can select the sort mode or group mode as necessary.

The paper sizes available for sort/group copying are LD, LG, LT, LT-R, COMP, A3, A4, A4-R, B4, B5 and FOLIO.

- Example of making 5 sets of copies from 5-page originals

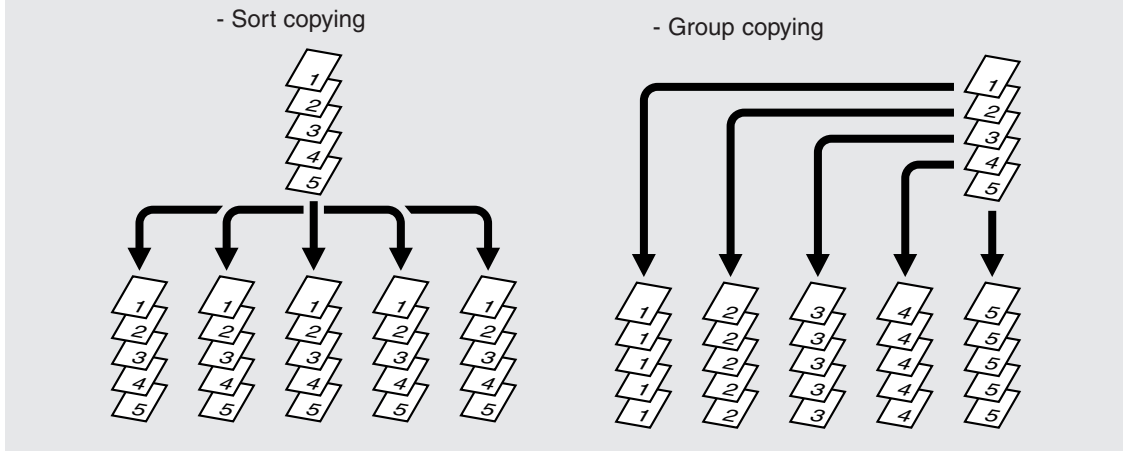

**1** Place paper in the drawer(s). ▶ Page 2-4

**2** Place the original(s). ▶ Page 2-9

**3** Press the key on the basic screen as shown on the right (shaded).

**Tip**

When originals are placed in the reversing automatic document feeder, the sort mode is automatically selected.

**4** Press the **(SORT)** (or **(GROUP)**) key.

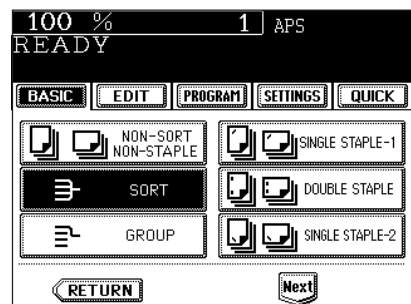
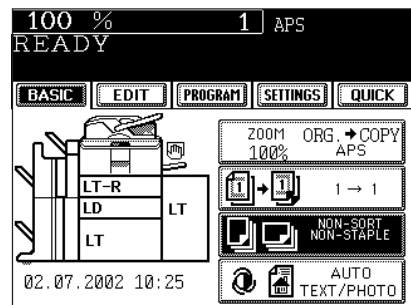

- Select other copy modes as required.

**5** Press the **(START)** key.

### 3. STAPLE SORTING (OPTIONAL)

When the optional finisher is installed, you can use the function that performs automatic stapling at one of the following three positions.

\* The paper weight should be in the range of 16lb. Bond - 28lb. Bond. Special paper such as OHP films or labels is excluded.

\* Stapling cannot be worked when the papers with different width are mixed.

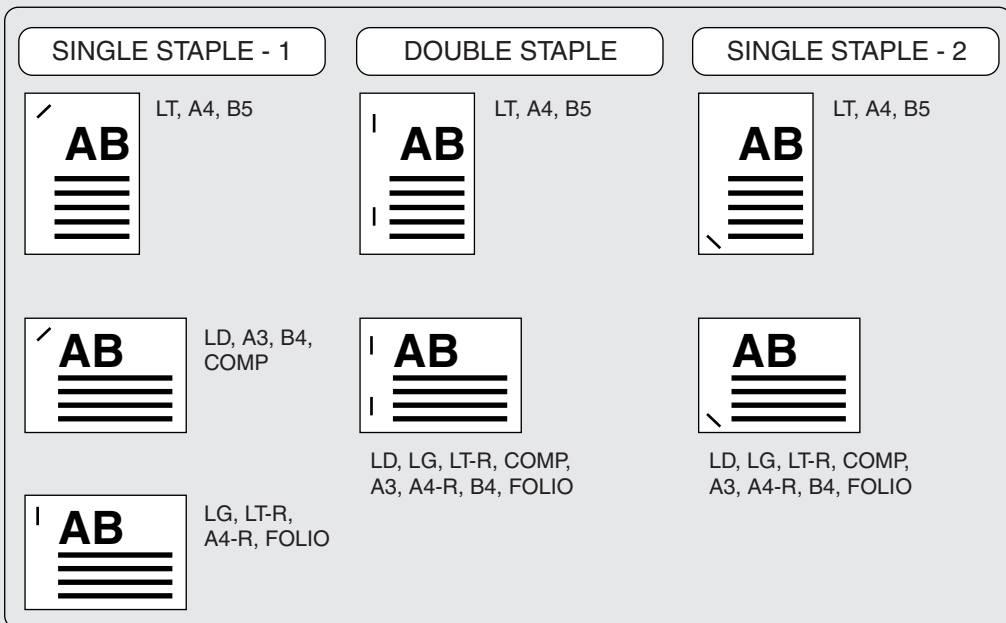
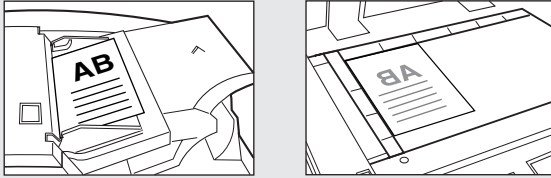

**1 Place paper in the drawer(s).** ▶ Page 2-4

- When using this mode in bypass copying (▶ Page 5-8), be sure to specify the paper size.

**2 Place the original(s).** ▶ Page 2-9

**3** Press the key on the basic screen as shown on the right (shaded).

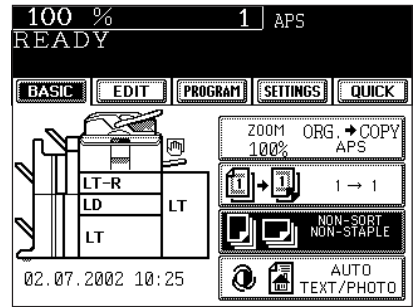

**4** Press the **(SINGLE STAPLE-1)** (or **(DOUBLE STAPLE)**, **(SINGLE STAPLE-2)**) key.

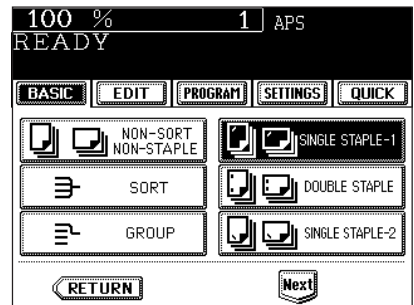

- Select other copy modes as required.

**5** Press the **(START)** key.

**Tip**

- If the paper quantity exceeds the maximum number of sheets that can be stapled, the finisher automatically enters the sort mode.

**Maximum Number of Sheets that can be Stapled**

When paper of different weights is loaded, the maximum number of sheets that can be stapled will be that of the paper with the highest weight.

Paper size	Paper weight		
	20 lb. Bond (Plain paper)	24 lb. Bond (Thick 1)	28 lb. Bond (Thick 1)
LT, A4, B5	50 sheets	30 sheets	30 sheets
LD, LG, LT-R, COMP, A3, A4-R, B4, FOLIO	30 sheets	15 sheets	15 sheets

\* Tray load capacity ► Page 9-4

## 4. MAGAZINE SORT & SADDLE STITCH MODE (BOOKLET MODE)

When the Magazine Sort mode is selected, 1-sided originals can be copied and bound like magazines or booklets. When a finisher with a saddle stitch (optional, AR-F12) is installed, you can select the saddle stitch mode which will automatically staple in the center of the document. LD, LT-R, A3, A4-R, B4 are available.

\* Special paper such as OHP films or labels is excluded.

\* Available paper weight for saddle stitch should be in the range of 16 lb. Bond -28 lb. Bond.

● Example of copying a 12-page document

- When **MAGAZINE SORT** is selected

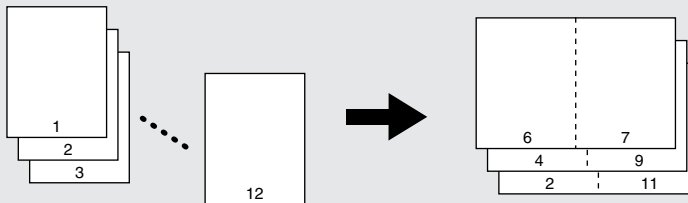

- When **MAGAZINE SORT & SADDLE STITCH** is selected

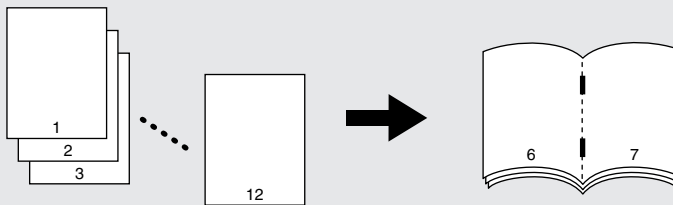

- When **SADDLE STITCH** is selected

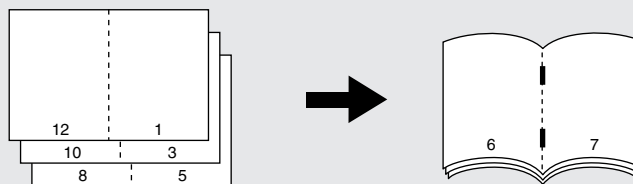

\*You can also select the Magazine Sort mode from the editing menu. ► Page 4-16

6

**1 Place paper in the drawer(s).** ► Page 2-4

**2 Set the paper size.**

For drawer feeding ► Page 3-3, step 3

For bypass feeding ► Page 5-10, step 4

**3 Place the original(s).** ► Page 2-9

- When placing them in the reversing automatic document feeder, set them by referring to the order of pages in the illustrations above.

- When placing them on the glass, place the first page of the originals first if **MAGAZINE SORT** or **MAGAZINE SORT & SADDLE STITCH** is selected. If **SADDLE STITCH** is selected, set them in the order of pages 12-1, (2-11), 10-3, (4-9), then 8-5, (6-7) by referring to the illustration above as an example.

**4** Press the key on the basic screen as shown on the right (shaded).

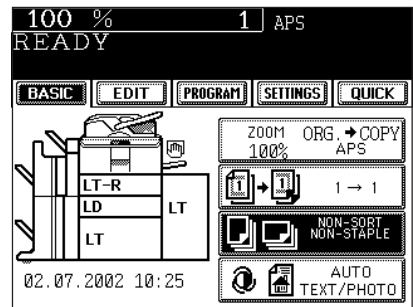

**5** Press the **MAGAZINE SORT** ( or **MAGAZINE SORT & SADDLE STITCH** or **SADDLE STITCH** ) key.

- If the desired function keys are not displayed, press the **Next** key to change the menu screen.

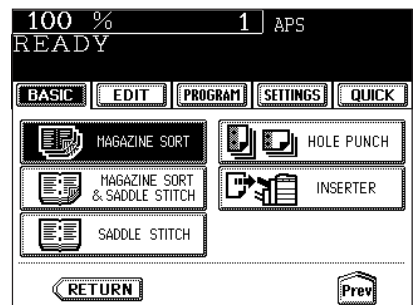

- Select other copy modes as required.

**6** Press the **START** key.

- When placing original(s) on the glass, perform steps 5 to 6 on page 2-2 to 2-3.

### Available Conditions for Saddle Stitch

When paper of different weights is loaded, the maximum number of sheets that can be stapled will be that of the paper with the highest weight.

Paper size	Paper weight	Maximum capacity for saddle stitch	Tray load capacity
LD LT-R A3 A4-R B4	20 lb. Bond (Plain paper)	10 sheets	Copying of 11-15 sheets: 10 copies Copying of 6 -10 sheets: 20 copies Copying of 5 sheets or less: 25 copies
	24 lb. Bond (Thick 1)	10 sheets	Copying of 11-15 sheets: 10 copies Copying of 6 -10 sheets: 20 copies Copying of 5 sheets or less: 25 copies
	28 lb. Bond (Thick 1)	10 sheets	Copying of 6 - 8 sheets: 15 copies Copying of 5 sheets or less: 25 copies

#### Tip

When the tray load capacity is exceeded, automatically switching to magazine sort mode.

# 5. HOLE PUNCH MODE (OPTIONAL)

With the optional hole punch unit attached to the optional finisher (AR-F11, AR-F12), you can have your copies punched with holes.

\* The paper weight should be in the range of 17 lb. Bond - 140 lb. Index. Special paper such as OHP films or labels is excluded.

- 1 Place paper in the drawer(s).** ▶ Page 2-4  
- When using this mode in bypass copying (▶ Page 5-8), be sure to specify the paper size.
- 2 Place the original(s).** ▶ Page 2-9
- 3 Press the key on the basic screen as shown on the right (shaded).**

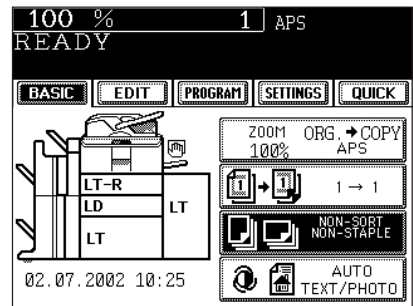

- 4 Press the **HOLE PUNCH** key.**  
- If the desired function keys are not displayed, press the **Next** key to change the menu screen.

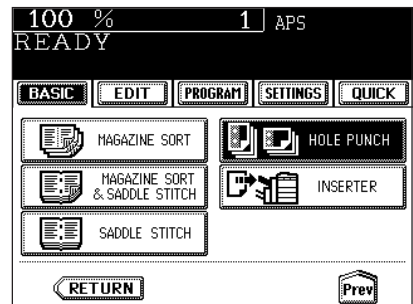

- Select other copy modes as required.

- 5 Press the **START** key.**

**Tip**

**Number of punch holes and available paper sizes:**

Since the number of punch holes and the distance between the holes vary depending on the country, purchase a hole punch unit that meets your requirements. (For details, consult your service technician.)

	Number of punch holes and hole diameter	Available paper sizes
North America (AR-PN3B)	2/3 holes switchable (0.315" dia.)	2 holes: LG, LT-R 3 holes: LD, LT, A3, A4



## 6. INSERTER MODE (OPTIONAL)

When you want to insert papers or use the staple or the hole punch functions without making copies, place the paper of the same size and direction in the optional inserter.

- If the sheets of paper are fed from more than one paper source ( Drawer, External LCF, Bypass guide, Inserter), set them all in the same size and direction.

### Paper Acceptable to Set in the Inserter

Paper size	LD, LG, LT, LT-R, COMP, A3, A4, A4-R, B4, B5, FOLIO
Paper type	Plain paper (16 lb. Bond - 20 lb. Bond), Thick paper (more than 20 lb. Bond- 140 lb. Index), Recycled paper, Special paper (OHP film, Color paper, Hole punch paper, etc.) (Ask your authorized Sharp dealer for the details of acceptable special papers.)
Maximum capacity	16 lb. Bond - 20 lb. Bond : 100 sheets more than 20 lb. Bond - 140 lb. Index : Loading height 0.63" or less (Special paper 0.275" or less)

\* The above paper may not be acceptable due to paper quality, etc.

\* When the paper set in the inserter is used for the staple or the saddle stitch, it is specified respectively.

- Staple ► Page 6-4
- Saddle stitch ► Page 6-7

### Setting Paper

#### 1 Place the paper in the inserter (optional) and align the slides to its size.

- Place paper in face up.
- For paper with a different top and bottom, place it in the same direction as that of original.
- Place the papers so that it does not extend beyond the line of indication shown on the slides.

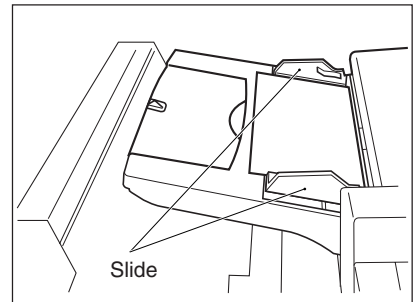

- When placing large paper, extend the tray as shown on the right.

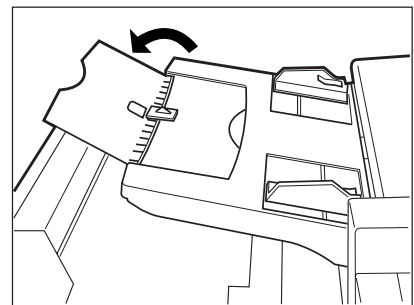

## 6. INSERTER MODE (OPTIONAL)(Cont.)

### Setting the Inserter

Blank paper placed in the optional inserter can be inserted into the pages you desire (including the front and back cover).

- When placing the paper for the initial (default) setting (LD and plain paper for the initial setting of the copier at the time of installation), the procedures from step 5 to 8 are not necessary.
- When you want to insert papers with making copies, place the paper in the drawer or on the bypass guide and select the cover sheet mode (▶ Page 4-18) or the sheet insertion mode (▶ Page 4-20) in the edit screen.

**1** Place paper in the inserter (optional). ▶ Page 6-9

**2** Place the original (s). ▶ Page 2-9

**3** Press the key (reversed in the right illustration) in the basic screen.

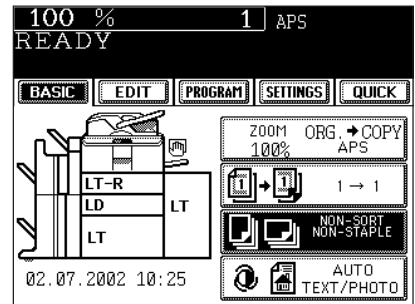

**4** Press the **INSERTER** key.  
- If the desired function keys are not displayed, press the **Next** key to change the menu screen.

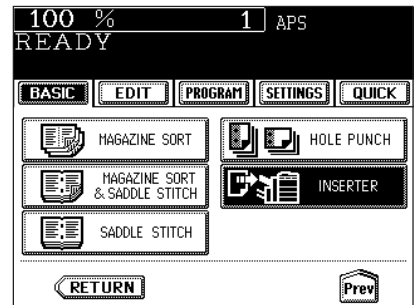

**5** Press the **SIZE** key.  
- For LD paper, skip step 5 and step 6 because these procedures are not necessary.

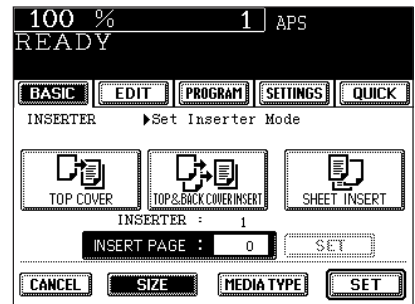

**6** Press the key of the paper size placed in the inserter.

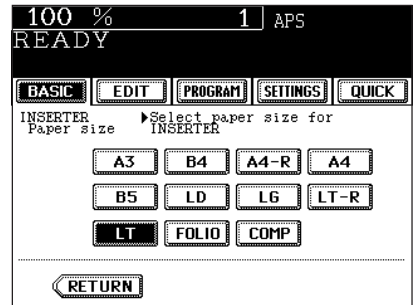

**7** Press the **MEDIA TYPE** key.  
 - For plain paper, skip step 7 and step 8 because these procedures are not necessary.

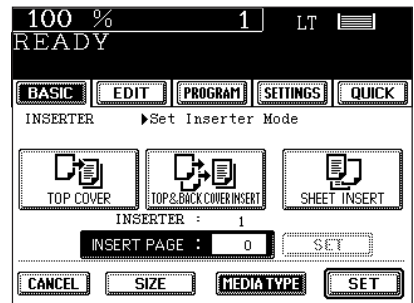

**8** Press the key of the paper size placed in the inserter, then press the **RETURN** key.

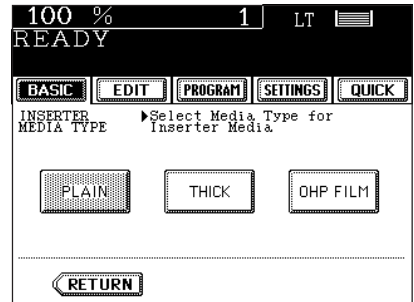

**Top Cover / Top & Back Cover Insert**

**9** Press **TOP COVER** (or **TOP & BACK COVER INSERT**) key, then press the **SET** key.  
 - For combining with the sheet insertion mode, press the **SHEET INSERT** key before pressing the **SET** key.

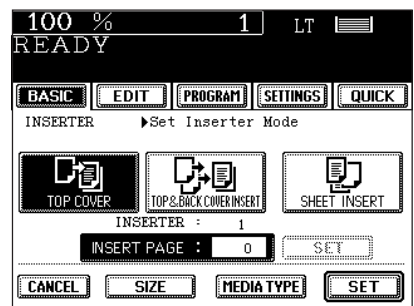

● Select other copy modes as required.

**10** Press the **START** key.

## 6. INSERTER MODE (OPTIONAL)(Cont.)

### Setting the Inserter (Cont.)

#### Sheet Insertion

Insertion of a blank sheet prior to the selected page

**9** Press the **SHEET INSERT** key.

**10** Key in the page number where you wish to insert the sheet, and press the upper **SET** key.

- When two or more sheets are inserted, repeat this procedure. Up to 15 insert locations can be specified in a single copy job.

**11** When specifying the page number is completed, press the lower **SET** key.

- For combining it with the cover sheet insertion of top cover (or top & back cover insert), press the **TOP COVER** (or **TOP & BACK COVER INSERT**) key before pressing the lower **SET** key.

● Select other copy modes as required.

**12** Press the **START** key.

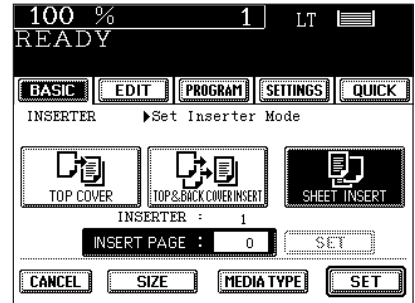

## Using only Staple and Hole Punch

When installing the optional inserter, you can use only the finishing mode (staple and hole punch). In that case, set it with the control panel on the inserter side.

- 1 Place paper in the inserter (optional) .** ▶ Page 6-9  
- In this condition, the start lamp lights in green.

### Tip

When saddle stitch is selected, place the paper with the pages facing up as shown on the right.

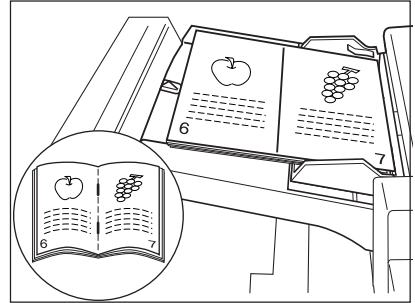

- 2 Set with the control panel of the inserter.**

- If you desire hole punch, press the ① key on the panel below. The lamp of the hole punch lights.
- If you desire staple or saddle stitch, press the ② key. (The lamp of the selected mode lights.)

### Tips

- Saddle stitch can be used only when the saddle stitch finisher is installed (with the AR-F12).
- You can use a combination of hole punch and staple, except saddle stitch.

- 3 Press the  START key.**

- At the beginning of the operation the start lamp flashes in green. After the end of the operation all the lamps which have lit up, go off.

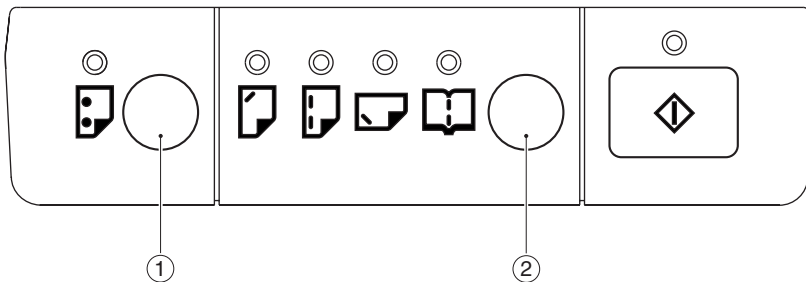



# 7. WHEN THE GRAPHIC SYMBOLS FLASH ON THE TOUCH PANEL

1. Description of the flashing graphic symbols .....	7-2
2. Add paper symbol .....	7-3
- Adding paper to the drawers .....	7-3
- Adding paper to the Tandem LCF (Large Capacity Feeder) .....	7-4
- Adding paper to the External LCF (Large Capacity Feeder)(optional) .....	7-5
3. Replace toner cartridge symbol .....	7-6
4. Clear paper symbol .....	7-9
① Reversing automatic document feeder .....	7-10
② Inside of the copier .....	7-12
③ Paper misfeed on the bypass guide .....	7-15
④ External LCF (optional) .....	7-15
⑤ Inserter (optional) .....	7-16
⑥ Hole punch unit (optional) .....	7-17
⑦ Finisher (optional) .....	7-18
⑧ Saddle stitch unit (optional) .....	7-19
5. Adding staples (optional) .....	7-21
6. Removing jammed staples (optional) .....	7-24
7. Disposing of accumulated punched paper bits (optional) .....	7-27
8. Call service symbol / Periodic maintenance message .....	7-28









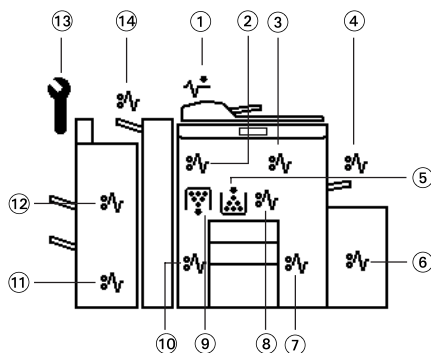





# 1. DESCRIPTION OF THE FLASHING GRAPHIC SYMBOLS

The graphic display on the touch panel shows the status of the copier. When one of the graphic symbols flashes, take the appropriate action referring to the page shown.

## Tip

When one of the graphic symbols flashes, press the **?HELP** key to display the guidance.



- ① CHECK ORIGINALS  symbol  
Flashes if an original misfeed occurs inside the reversing automatic document feeder. ► Page 7-10
- ② PAPER EXIT MISFEED  symbol  
Flashes if a paper misfeed occurs at the paper exit. ► Page 7-12
- ③ PAPER PATH MISFEED  symbol  
Flashes if a paper misfeed occurs on the paper path inside the copier. ► Page 7-12
- ④ BYPASS MISFEED  symbol  
Flashes if a sheet of paper fails to be fed into the copier during bypass copying. ► Page 7-15
- ⑤ REPLACE TONER CARTRIDGE  symbol  
Flashes when the toner cartridge runs out of toner. ► Page 7-6
- ⑥ EXTERNAL LCF MISFEED  symbol  
Flashes if paper fed from the External LCF (optional) is misfed. ► Page 7-15
- ⑦ DRAWER MISFEED  symbol  
Flashes when paper fed from one of the drawers is misfed. ► Page 7-12
- ⑧ DUPLEXER MISFEED  symbol  
Flashes if a paper misfeed occurs inside the automatic duplexer. ► Page 7-12
- ⑨ REPLACE TONER BAG  symbol  
Flashes when the toner bag becomes full of used toner. Please call your service technician to ask to have the used toner bag replaced with a new one. ► Page 7-8
- ⑩ INVERTER MISFEED  symbol  
Flashes if a paper misfeed occurs in the inverter during duplex copying. ► Page 7-12
- ⑪ SADDLE STITCH UNIT MISFEED  symbol  
Flashes if a paper misfeed occurs inside the saddle stitch of the finisher (option). ► Page 7-19
- ⑫ FINISHER/HOLE PUNCH UNIT MISFEED  symbol  
Flashes if a paper misfeed occurs inside the finisher (optional) or the hole punch unit (optional). ► Page 7-17, 7-18
- ⑬ CALL SERVICE  symbol  
Flashes if inspection and maintenance by your service technician become necessary. ► Page 7-28
- ⑭ INSERTER UNIT MISFEED  symbol  
Flashes if a paper misfeed occurs in the inserter unit (optional). ► Page 7-16



## 2. ADD PAPER SYMBOL

### Adding Paper to the Drawers

When the paper supply in the selected drawer or Tandem LCF (Large Capacity Feeder) runs out, the drawer or External LCF (Large Capacity Feeder)(optional) shown on the display flashes, and the following message appears:

Add paper

Add paper as follows.

- 1 Pull the drawer out carefully until it comes to a stop.**

- Be careful not to touch the drawer slide rail.

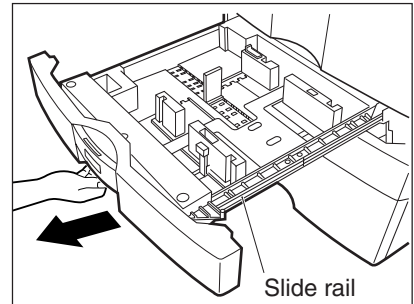

- 2 Place the paper in the drawer.**

- Place the paper face down.  
- Maximum number of sheets that can be set. ► Page 2-4  
- Fan the paper well before placing it in the drawer.  
- Do not add paper above the line indicated on the guide.  
- Do not use creased, folded, wrinkled or damp sheets of paper.

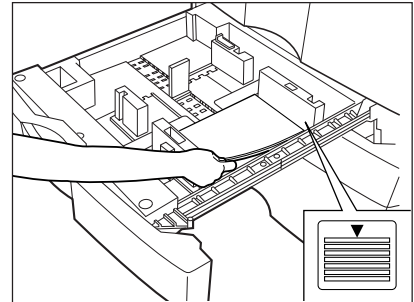

#### Note

Make sure that a gap of approx. 0.5 mm (less than 1 mm in total) is left between the paper and the side guide. If there is no gap, this may cause paper misfeeding.

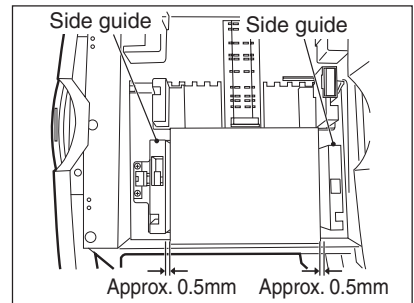

- 3 Push the drawer straight into the copier until it comes to a stop.**

- Be sure to push the drawer carefully and fully in.

#### Note

Be careful not to let your fingers be caught when closing the drawer.

## 2. ADD PAPER SYMBOL (Cont.)

### Adding Paper to the Tandem LCF (Large Capacity Feeder)

#### 1 Pull the tandem LCF out carefully until it comes to a stop.

- Be careful not to touch the drawer slide rail.

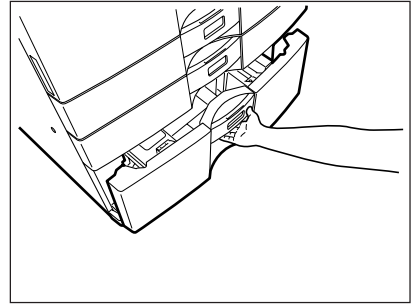

#### 2 Open some packages of paper, take out entire reams of paper and set them aligned in tray (A) and tray (B).

- When setting the paper, set the paper for (A) to the right side, and set it for (B) to the left side. (The paper can be set neatly if you pile it up gradually and alternately in trays (A) and (B).) Be sure that the center lever is not open ( refer to the labels attached in the tandem LCF ).
- Up to 2500 sheets of paper (20 lb.Bond) can be set.
- Paper starts being fed from the elevator tray (A) at first, and when it runs out of paper, the paper on tray (B) moves to the position (A).
- Set the paper so that it does not protrude beyond the line of indication shown on the rear guide plate.
- Do not use creased, folded, wrinkled or damp sheets of paper.
- Be careful not to touch the drawer slide rail.

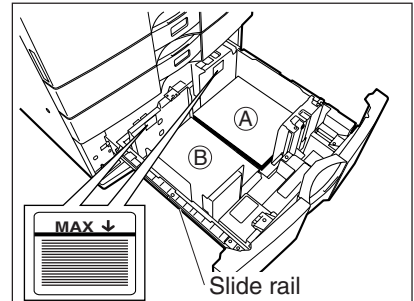

7

#### 3 Close the cover of the tandem LCF.

- Close the drawer completely. The elevator tray automatically moves up to the paper feeding position.

#### Note

Be careful not to let your fingers be caught when closing the drawer.

## Adding Paper to the External LCF (Large Capacity Feeder)(optional)

### 1 Pull the external LCF out carefully until it comes to a stop.

- Be careful not to touch the drawer slide rail.

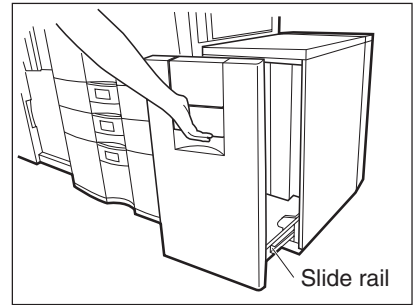

### 2 Place the paper on the elevator tray.

- Place the paper face up.
- Maximum number of sheets that can be set ► Page 2-4
- Fan the paper well, then place it on the elevator tray, aligning it on the rear guide tray.
- Set the paper so that it does not protrude beyond the line of indication shown on the rear guide plate.
- Do not use creased, folded, wrinkled or damp sheets of paper.

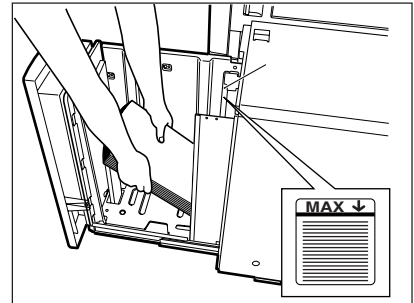

### 3 Close the cover of the external LCF.

- Close the cover completely. The elevator tray automatically moves up to the paper feeding position.

#### Note

Be careful not to let your fingers be caught when closing the drawer.

# 3. REPLACE TONER CARTRIDGE SYMBOL

When the toner cartridge runs out of toner, the REPLACE TONER CARTRIDGE  symbol flashes,

Add toner

This message will appear on the screen.

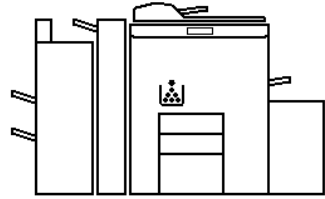

## Note

Use only toner cartridges made or designated by Sharp in order to optimize copy quality.

**1** Open the front cover.

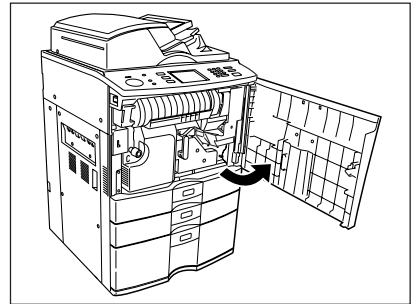

**7**

**2** Rotate the left end of the holder, then pull out the empty toner cartridge with both hands as shown on the right.

## Note

Return used toner cartridges to your service technician.

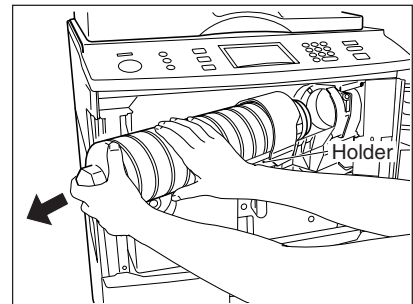

**3** Shake the new toner cartridge well to loosen the toner inside.

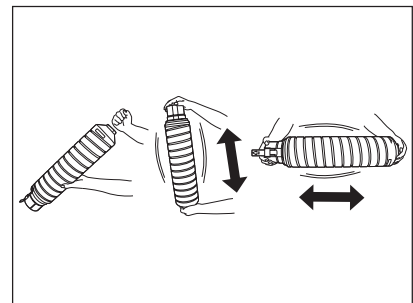

- 4** Holding the new toner cartridge as shown on the right, pull out the seal in the direction of the arrow.

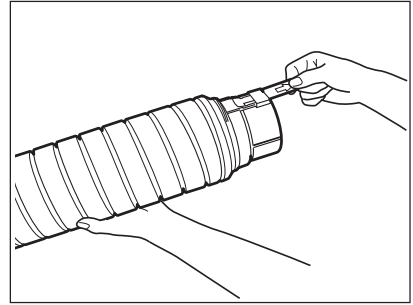

- 5** Match the label(orange) on the copier with the shutter(orange) on the toner cartridge, then insert the toner cartridge to the end.

- If you cannot insert the toner cartridge completely, rotate it slightly to check the position and insert it again.
- If the toner scatters, wipe it off completely.

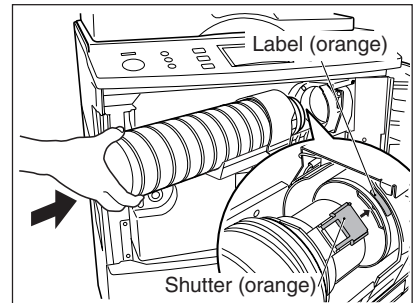

- 6** Return the toner cartridge holder back to its original position.

- 7** Close the front cover.

- The following message appears:

Wait adding toner

The copier automatically starts supplying toner.

- When toner has finished being supplied, the touch panel returns to the basic menu and the current job automatically resumes.

### 3. REPLACE TONER CARTRIDGE SYMBOL (Cont.)

#### Additional Explanation

The life of the toner cartridge (number of copies) varies depending on the following conditions.

Coverage of originals (printing ration of copies) varies depending on the following conditions :

1. Size and density of originals
2. The existence of solid black when making copies (when a book is copied and the original cover is partially open )
3. Temperature and humidity in the room when making copies
4. Copy density and image quality mode

As indicated in the figure below, the life of the toner cartridge varies depending on the copy mode and the coverage of the originals

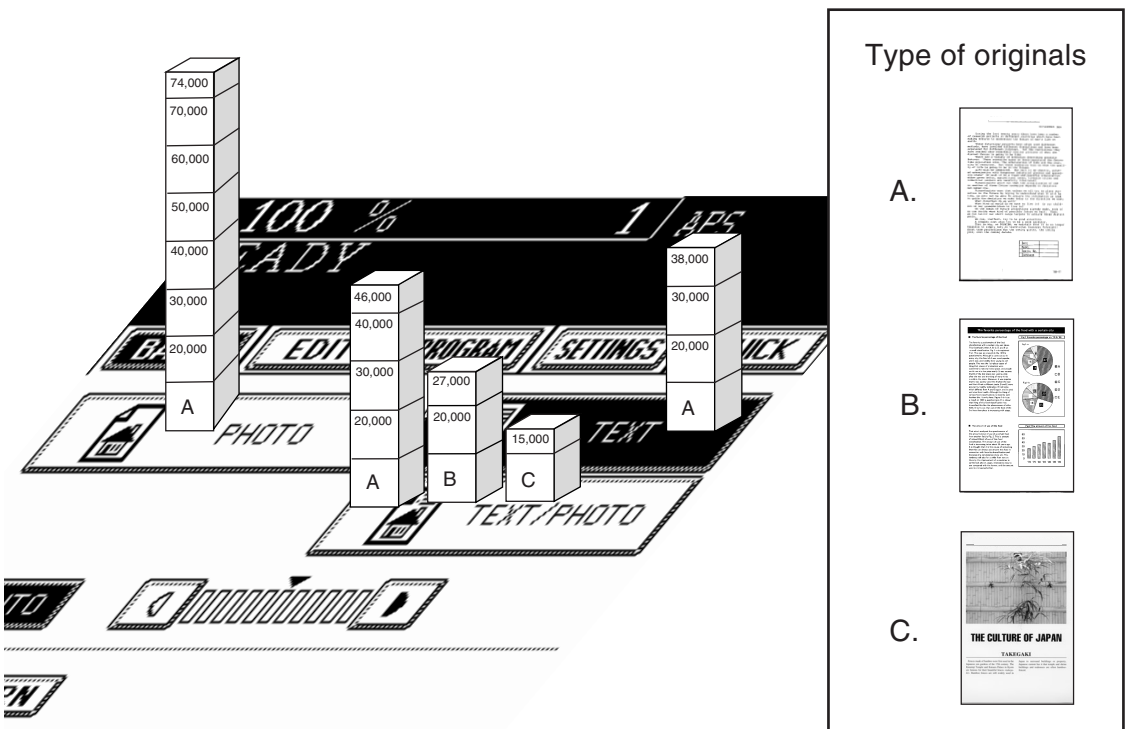



#### Dispose of Used Toner

##### Replace Toner Bag

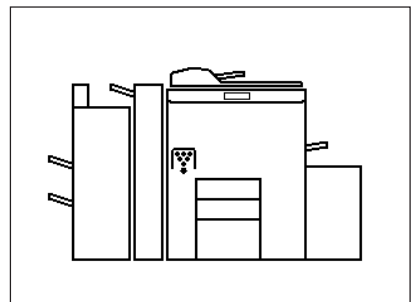
- When the toner bag becomes full of used toner, the REPLACE TONER BAG  symbol flashes. Please call your service technician to ask to have the used toner bag replaced with a new one.



# 4. CLEAR PAPER SYMBOL

When a paper misfeed occurs in the copier, the  or  symbol flashes in the positions where the paper is misfed. In that case, remove the misfed paper using the following procedure referring to the illustration below.

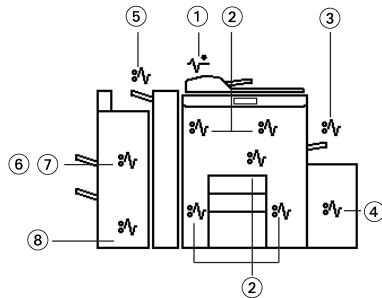

- ① Reversing Automatic Document Feeder
- ② Inside of the Copier
- ③ Bypass Guide
- ④ External LCF (optional)
- ⑤ Inserter (optional)
- ⑥ Hole Punch Unit (optional)
- ⑦ Finisher (optional)
- ⑧ Saddle Stitch Unit (optional)

## - Moving the finisher (optional)

Depending on where a paper jam has occurred, it may be necessary to move the optional finisher. ( including the inserter and the hole punch unit.)

### - Separating it from the copier

While pressing the release lever ①, gently move the finisher (position ①) (including the hole punch unit) away from the copier. If an inserter has been installed, place your hands in position ② instead.

\* Move the options parallel to the copier.

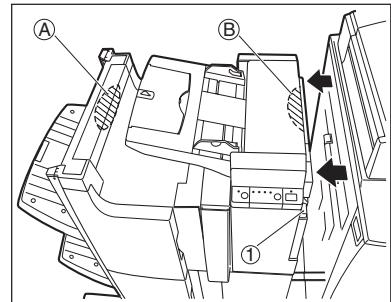

### - Connecting with the copier

Placing your left hand in the position shown in the figure on the right, gently connect the finisher (including the hole punch unit) with the copier placing your right hand on ③. If an inserter is to be installed, place your right hand on ④ instead.

#### Note

When installing the options, be careful not to let your fingers be caught between them and the copier.

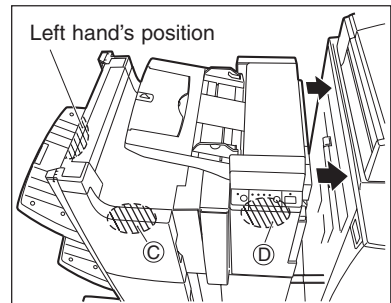

## 4. CLEAR PAPER SYMBOL (Cont.)

### ① Paper Misfeed in the Reversing Automatic Document Feeder

- 1** Push the button on the reversing automatic document feeder to open the cover.

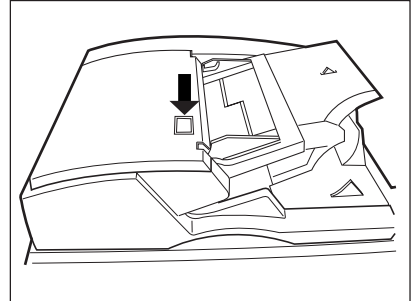

- 2** Rotate the blue knob to remove any misfed originals.

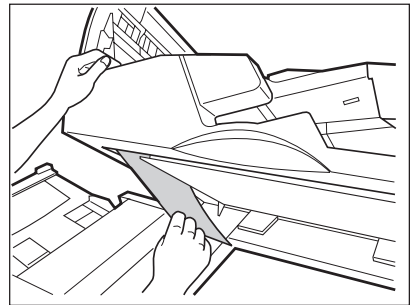
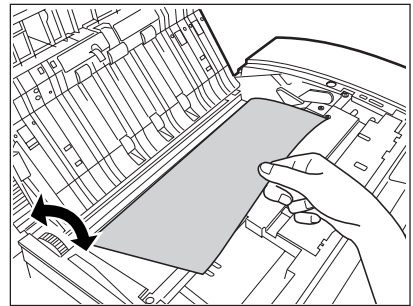

- 3** Lift the blue handle (first) as shown on the right.  
- If there are any misfed originals, remove them.

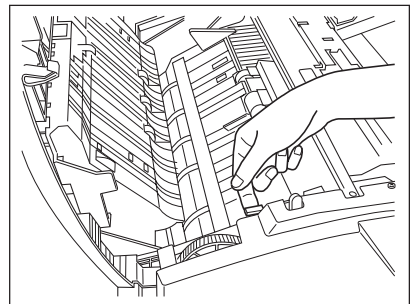



- 4** Lift the blue handle (second) as shown on the right.  
- If there are any misfed originals, remove them.

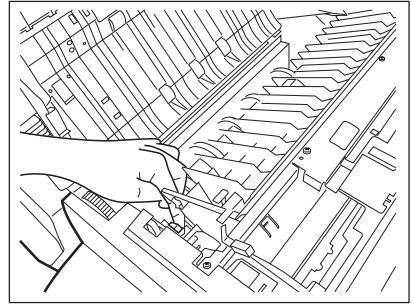

- 5** Lift the original feeding tray and remove any misfed originals.

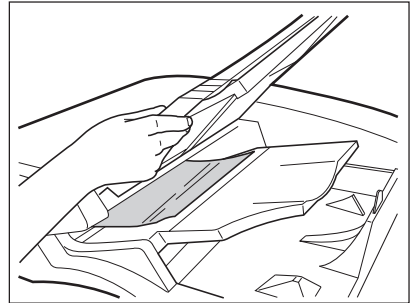

- 6** Open the original exit tray and remove any misfed originals.

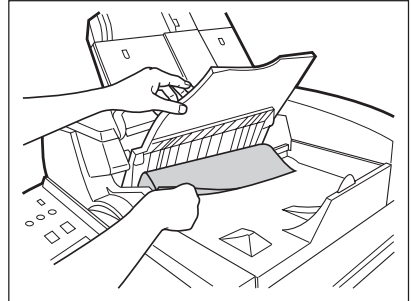

- 7** Lifting the handle in the direction of the arrow, pull it toward you.

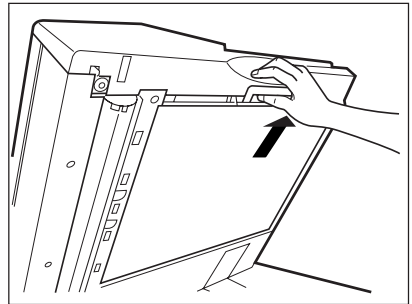

- 8** Remove any misfed originals.

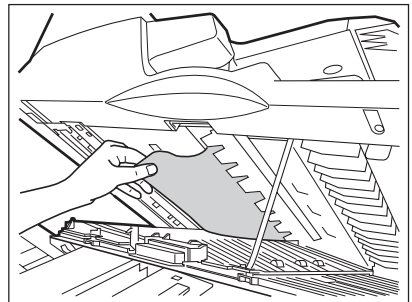

## 4. CLEAR PAPER SYMBOL (Cont.)

### ② Paper Misfeed inside of the Copier

#### 1 Open the paper feed cover.

- When installing the external LCF (optional), open the paper cover after doing step 1 of page 7-15.



#### 2 Remove any misfed paper.

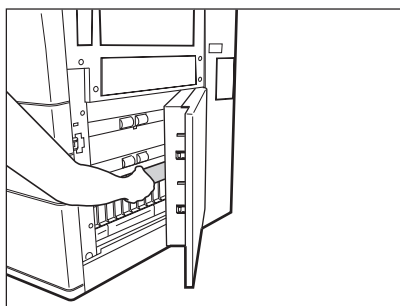

7

#### 3 Open the bypass cover.

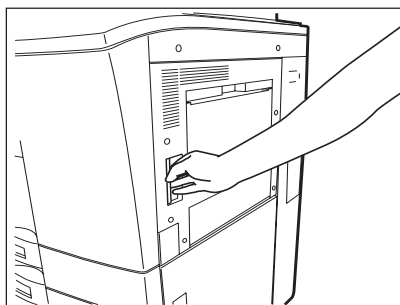

#### 4 Remove any misfed paper.

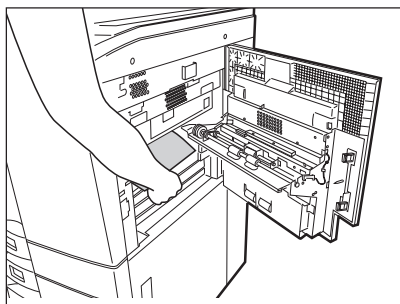

## 5 Open the exit cover.

- For how to connect or separate the optional finisher.  
▶ Page 7-9

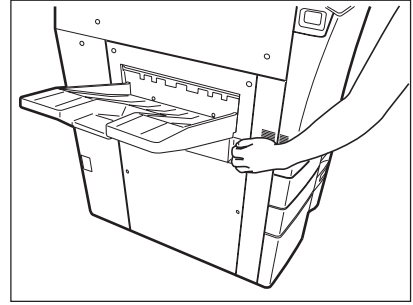

## 6 Remove any misfed paper.

- If any paper is misfed in the cover, pull it out.

### Caution

Do not touch the metal area of guide plate in the automatic duplexer. You might burn yourself.

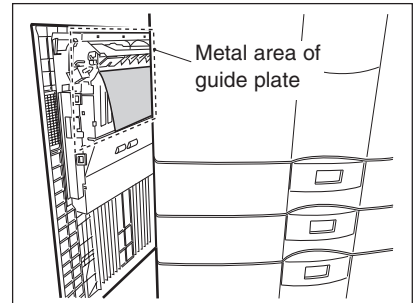

- If any paper is misfed in the copier, open the front cover and remove any misfed paper by turning the knob in the direction of the arrow.

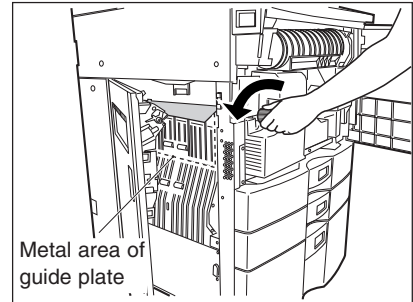

- If any paper is misfed in the position on the right, pull it out.

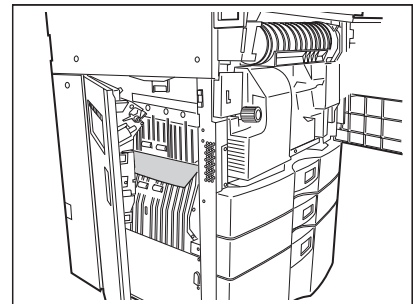

## 7 Turn the handle in the direction of the arrow.

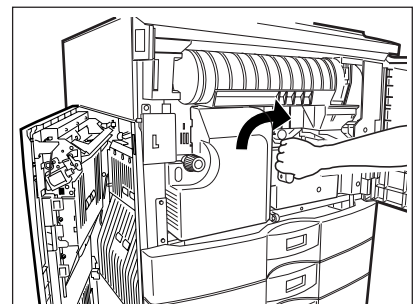

**8** Pull the transfer unit out until it comes to a stop.

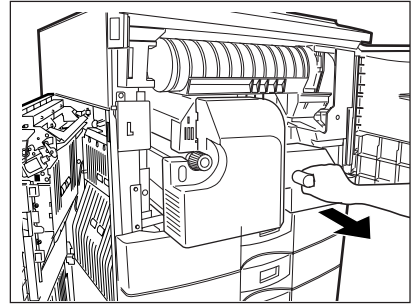

- If a sheet of paper is misfed on the transfer belt, remove it.

**Tips**

- Do not put some objects on the transfer belt or do not touch it.
- When a sheet of paper is caught in fuser unit, do not pull out directly but remove based on step 9.

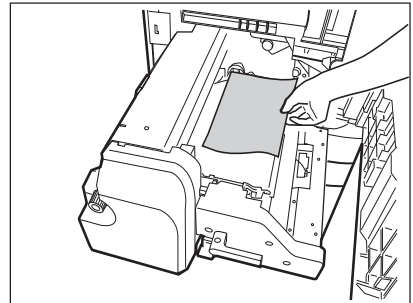

**9** Lift the grip, then turn the knob in the direction of the arrow to remove any misfed paper.

**Caution**

Do not touch the fuser unit and around the metal area. You may be burned or be injured if you come into contact with the inner area in the fuser due to high temperature.

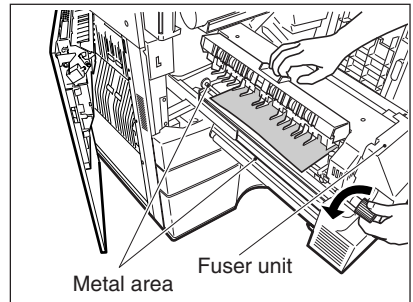

**10** Pick the lever of the transfer unit as shown on the right and open the bottom (automatic duplexer).

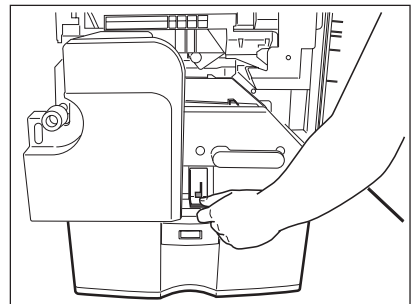

**11** Remove any misfed paper.

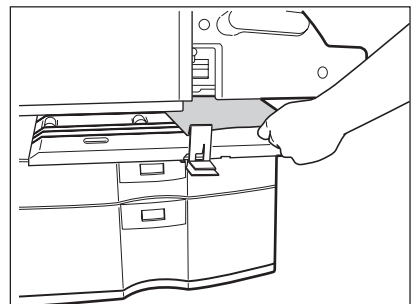

### ③ Paper Misfeed on the Bypass Guide

- 1 Pull up the misfed paper slowly on the bypass guide.

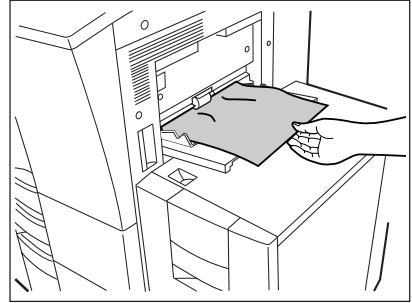

### ④ Paper Misfeed in the External LCF (Large Capacity Feeder) (optional)

- 1 Pull the external LCF away from the copier slowly while pressing the release lever.

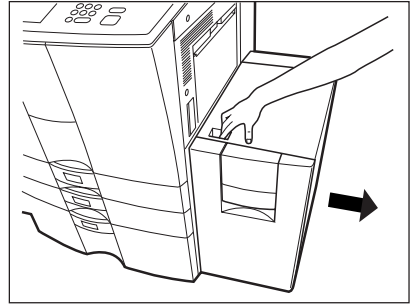

- 2 Remove any misfed paper by turning the blue knob in the direction of the arrow.

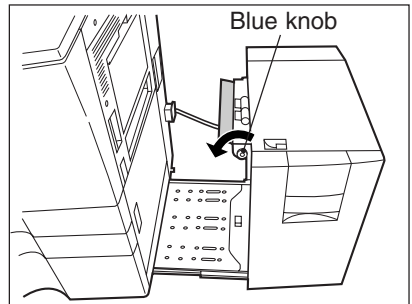

- 3 When paper misfeeds inside of the copier, pull up and out the misfed paper.

- If unable to easily pull out the misfed paper, open the bypass guide cover and pull (A), then remove the misfed paper.

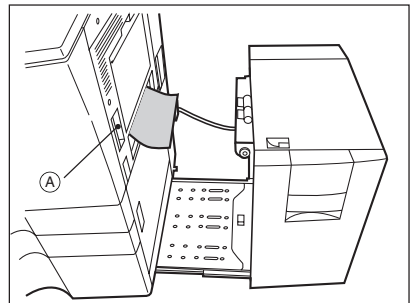

### 4 Open the cover of the external LCF and remove any misfed paper.

- Be careful not to touch the drawer slide rail.

#### Note

Be careful not to let your fingers be caught when closing the drawer.

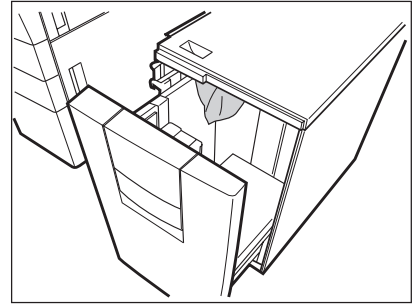

### 5 Return the external LCF to its original position.

- As shown in the figure on the right, place your hands on B to enable you to slowly reconnect it to the copier while maintaining both machines parallel to one another.

#### Note

When installing the external LCF, be careful not to let your fingers be caught between it and the copier.

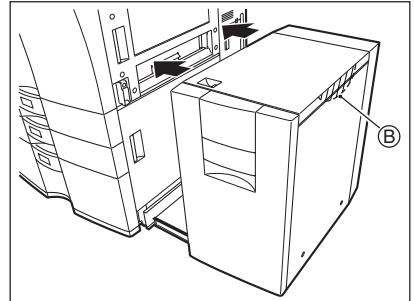

### 5 Paper Misfed in the Inserter (optional)

7

### 1 Pull the inserter (optional) away from the copier slowly.

- For the method of separating the finisher from the copier.

► Page 7-9

### 2 Open the cover while lifting the grip.

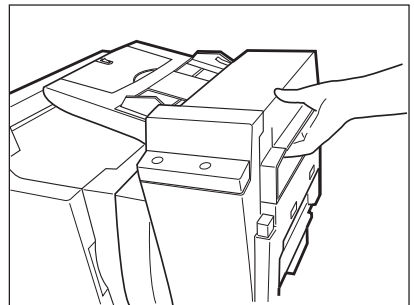

### 3 Remove any misfed paper.

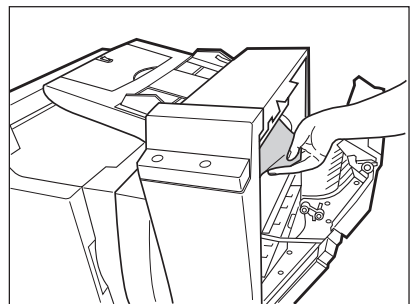

**4** Pull down the grip.

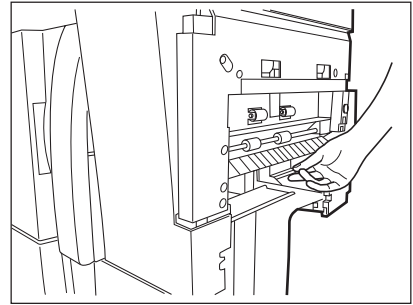

**5** Remove any misfed paper.

**Tip**

Jammed paper might not be able to be removed while the hole punch unit is used. In this case, perform the steps in

⑥ Paper Misfeed in the Hole Punch Unit .

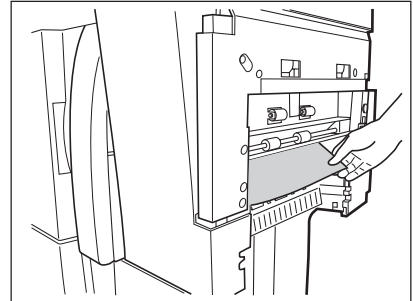

**6** Open the tray of the inserter to remove any misfed paper.

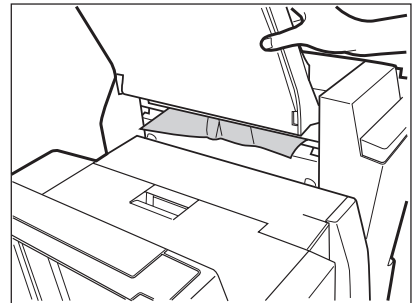

⑥ Paper Misfeed in the Hole Punch Unit (optional)

**1** Open the cover of the hole punch unit.

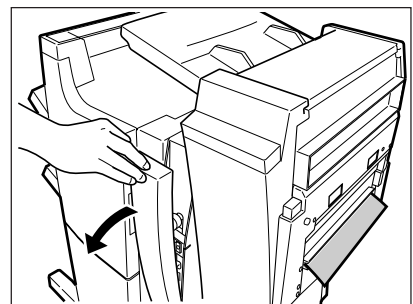

## 4. CLEAR PAPER SYMBOL (Cont.)

**2** Rotate the blue knob to locate the arrow within the area **A** on the label.

- Under this condition, the punchers are up, allowing the paper shown in the figure to be removed.

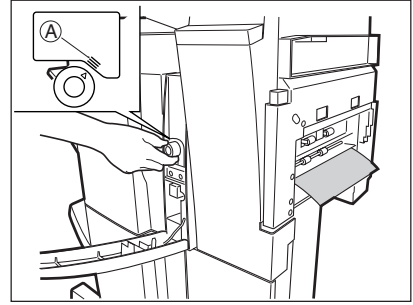

### ⑦ Paper Misfeed in the Finisher (optional)

**1** Open the upper cover of the finisher.

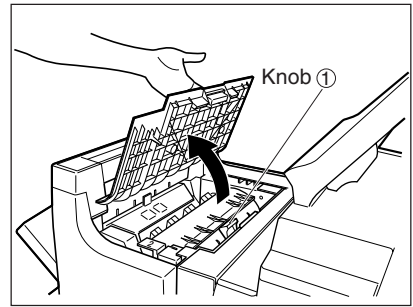

**7** **2** Lift knob **①** (See the upper right figure), then remove any misfed paper.

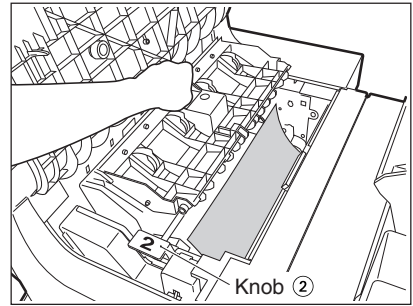

- For the paper misfed in the position shown on the right, pull the knob in the direction of the arrow, then remove it.

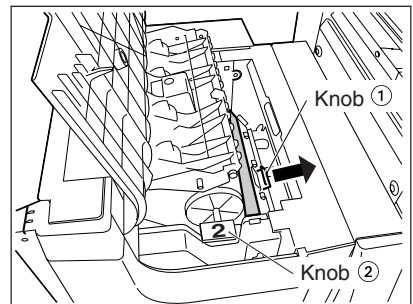



- 3** Lift knob ② and then remove any misfed paper.  
(② is indicated in the illustration of step 2 on page 7-18.)

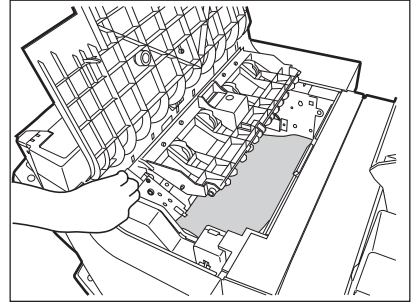

- 4** Remove any misfed paper from the paper exit area.

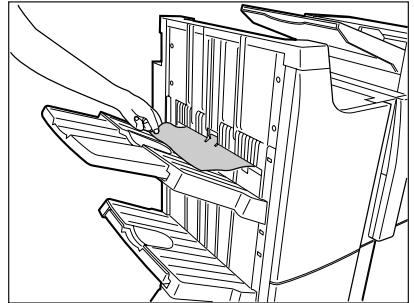

⑧ Paper Misfeed in the Saddle Stitch Unit (optional)

\* Only when the saddle stitch finisher (AR-F12) is installed.

- 1** When installing the optional inserter, open the lower cover of the inserter.

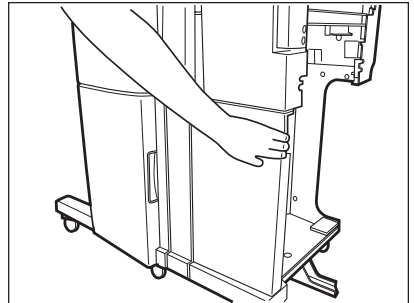

- 2** Open the entrance cover of the saddle stitch unit.

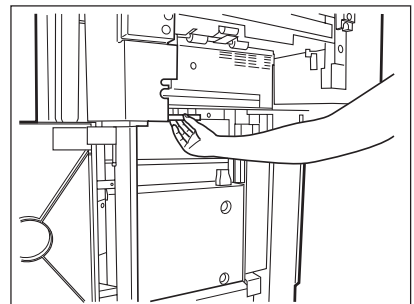

## 4. CLEAR PAPER SYMBOL (Cont.)

**3** Remove any misfed paper.

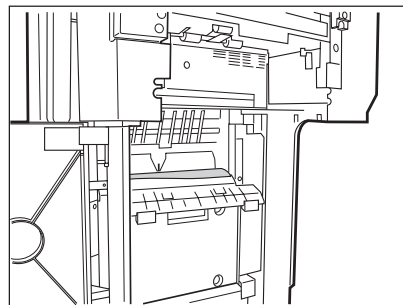

**4** Open the lower cover of the finisher.

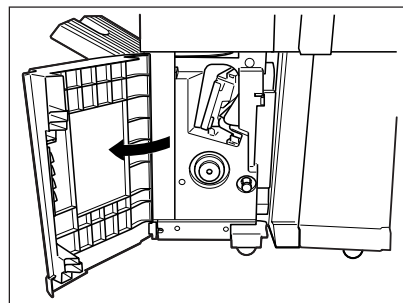

**5** Turn the right-hand knob ① counter clockwise. Then, push the left-hand knob ② and turn it clockwise.

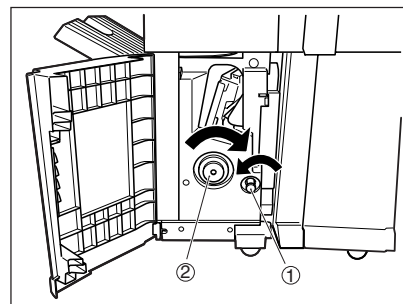

**6** Remove any paper misfed on the exit side of the saddle stitch unit.

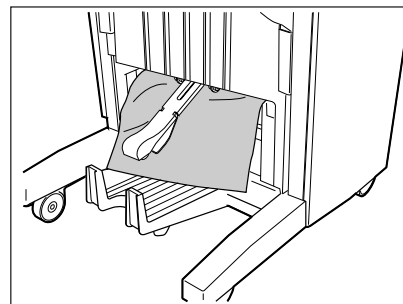

**7** Open the exit cover of the saddle stitch unit and remove any misfed paper.

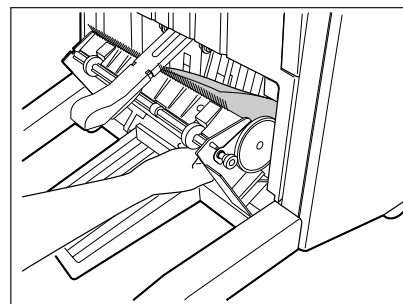

## 5. ADDING STAPLES (OPTIONAL)

When the staple cartridge runs out of staples, if the optional finisher is installed, the following message appears:

Set staple cartridge

Add staples to the cartridge according to the procedure below.

### Finisher

- 1** Open the front cover of the finisher.

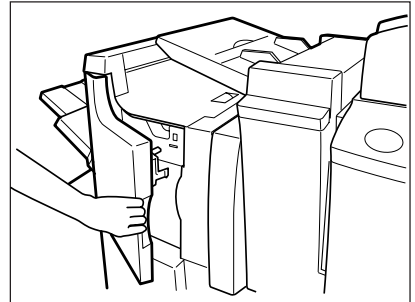

- 2** Lower the blue lever in the stapler and slide out the staple cartridge.

- The stapler unit has moved to its specified position.
- Do not move the stapler unit while performing the above procedure, or it will be broken.

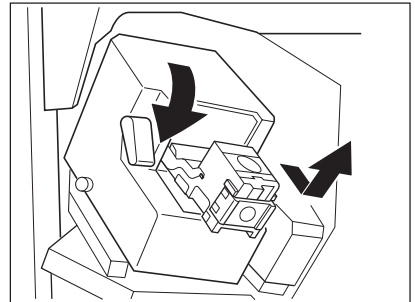

- 3** Remove the empty staple case upward from the staple cartridge.

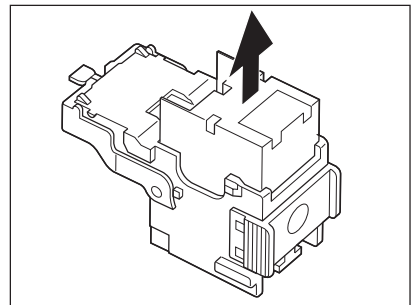

- 4** Push in a new staple case into the staple cartridge completely inside until a click is heard.

- Do not remove the seal holding the staples until the staple case is set in the cartridge.

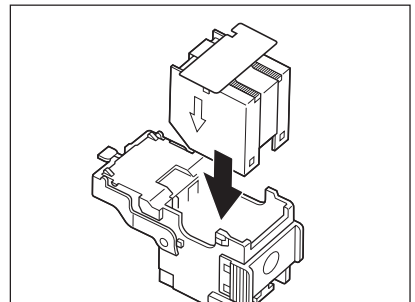

## 5. ADDING STAPLES (OPTIONAL) (Cont.)

**5** Pull out the seal holding the staples straight upward.

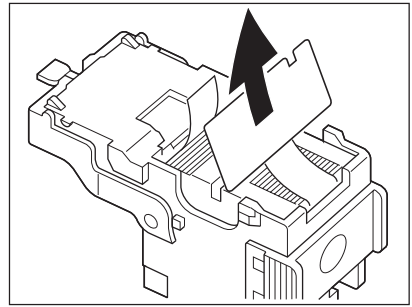

**6** Return the staple cartridge to its original position.  
- Insert the cartridge until it is caught by the claw and fixed with a click sound.

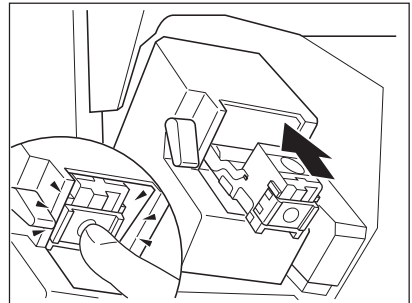

**7** Close the front cover of the finisher.

**Note**

If the following message remains displayed, repeat the above procedure from ① to ⑦.

Set staple cartridge

**7**

### Saddle Stitch Unit

\* Only when the saddle stitch finisher (AR-F12) is installed.

**1** Open the lower cover of the saddle stitch finisher.

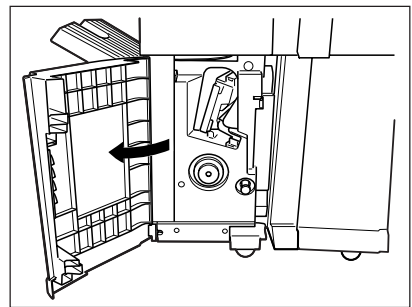

**2** Slide out the saddle stitch unit carefully toward the front.

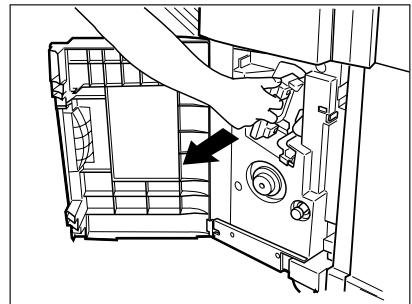

- 3** Pull out the grip of the saddle staple holder ① toward you and turn it ② 90° clockwise in the direction of the arrow.

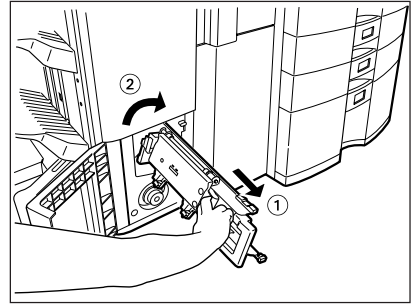

- 4** Remove the empty staple case and set a new one.
- Replace both staple cases with new ones.
  - Do not remove the seal holding the staples before the staple case is set in the cartridge.

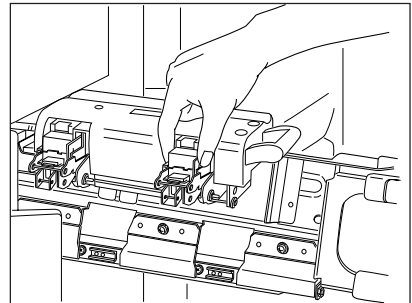

- 5** Return the saddle stitch holder and the saddle stitch unit to their respective original positions.
- 6** Make sure that the finisher is attached to the copier firmly and that LD, LT-R size paper is set in the copier.
- If one of the above paper sizes is not set, test stapling cannot be performed.
- 7** Close the lower cover of the finisher. Test stapling is then automatically performed on a blank sheet.
- This operation is carried out to avoid blank stitching.

**Note**

If test stapling fails to be performed and the following message remains displayed, repeat the above procedure from steps 1 to 7.

Set staple cartridge

## 6. REMOVING JAMMED STAPLES (OPTIONAL)

When copies have not been stapled in the staple mode, the following message may be shown on the display:

Examine stapler

This means that staples have become jammed. Remove them as described below.

### Finisher

**1** Perform steps 1 to 2 of the procedure for “5. ADDING STAPLES **Finisher**” (▶ Page 7-21).

**2** Holding the knob, lower part <sup>Ⓐ</sup>.

#### Caution

Do not touch the stapling area.  
The stapler could injure you.

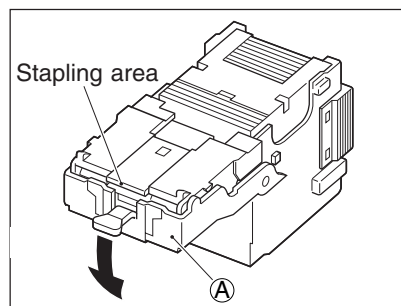

7

**3** Remove any jammed staples using your fingertip or something sharp.

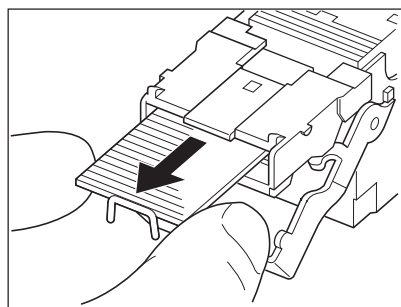

**4** Holding the knob, return part <sup>Ⓐ</sup> to its original position.

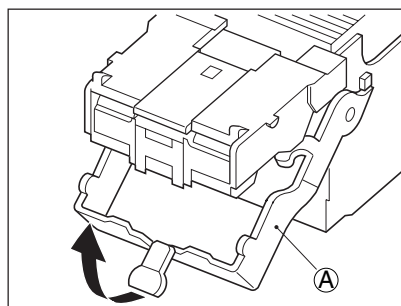

- 5** Return the staple case to its original position.  
 - Insert the cartridge until it is caught by the claw and fixed with a click sound.

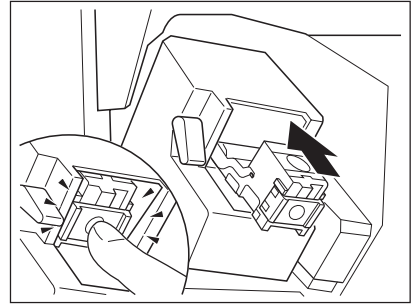

- 6** Close the front cover of the finisher.

Saddle Stitch Unit

- 1** Perform steps 1 to 3 of the procedure for “ 5. ADDING STAPLES Saddle Stitch Unit ”( ▶ Page 7-22, 7-23).

- 2** Remove the empty staple case.

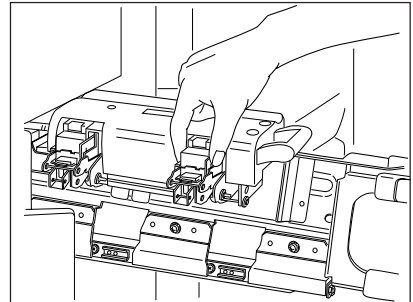

- 3** While pushing down on level ①, pull up knob ②.

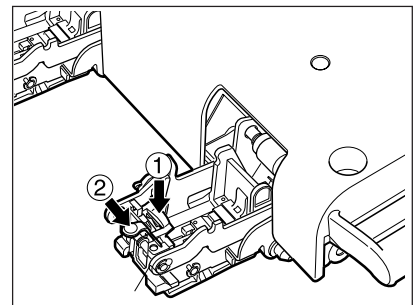

- 4** Remove any jammed staples, and then return knob ② to its original position.

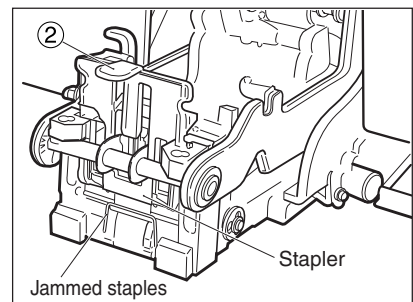

## 6. REMOVING JAMMED STAPLES (OPTIONAL) (cont.)

**5** Return the staple case to its original position.

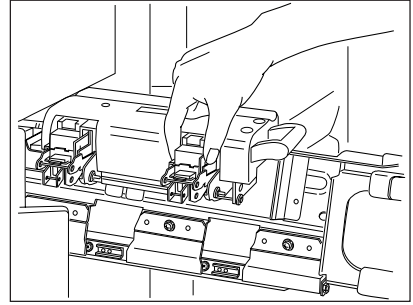

7



## 7.DISPOSING OF ACCUMULATED PUNCHED PAPER BITS (OPTIONAL)

When paper bits punched from copies have accumulated to a certain level, the following message appears.

Please Dispose of Hole Punch Dust

Dispose of the paper bits as described below.

- 1** Open the cover of the hole punch unit.

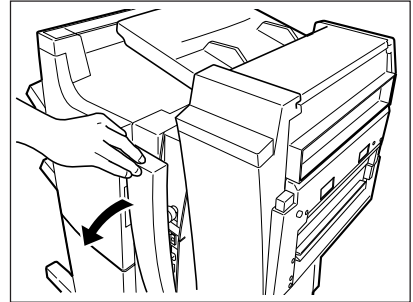

- 2** Holding the black handle, slide out the case containing the paper bits, and dispose of them properly.

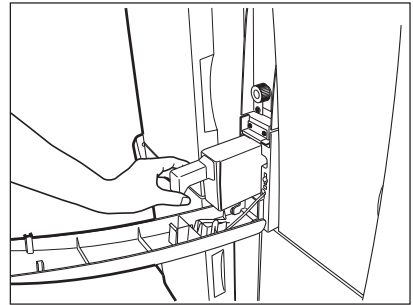

- 3** Return the waste case to its original position.
- 4** Close the cover of the hole punch unit.

## 8. CALL SERVICE SYMBOL / PERIODIC MAINTENANCE MESSAGE



### CALL SERVICE SYMBOL

When the CALL SERVICE  symbol flashes, the following message appears and copying is no longer possible. Call your service technician.

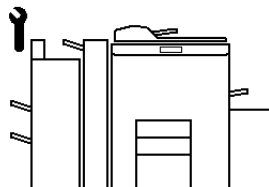
Call for service



#### Note

When the CALL SERVICE  or CLEAR PAPER  symbol is flashing, if you press the **C Clear** key and the digital key  together before you turn off the power, the corresponding error code will appear on the copy quantity display only while both keys are held down. Please give the error code in addition when you are asking for service.

#### Tip

Since heaters are used to fix toner images to the copy paper, a safety circuit is incorporated in this copier. After you turn on the power switch, if a certain temperature is not attained within a specified period of time, the safety circuit assumes that something abnormal has happened, causing the copier to stop its operation. This can possibly occur when the temperature is low even if the copier is not malfunctioning. If this occurs, turn the power switch off and then on again. Repeat this procedure twice, and if the problem still persists, turn off the power switch and call for service.

7

### PERIODIC MAINTENANCE MESSAGE

The following message may appear on the display panel:

Time for periodic maintenance

or

Time for periodic maintenance  
(Fuser cleaning web)

This indicates that assistance from a qualified service technician is required. Call your service technician for assistance.

#### Tip

Using the copier continuously without replacing the fuser cleaning web causes dirty image.

# 8. MAINTENANCE

1. Daily inspection .....	8-2
2. Simple troubleshooting .....	8-3

# 1. DAILY INSPECTION

## Items for Daily Check

### Power switch ON/OFF status

We recommend turning the power switch ON at the startup everyday so that copies can be made whenever you want. Also, be sure to turn the power switch OFF when you leave the office. In the following cases, do not turn the power switch OFF.

- when the off-mode (or sleep mode) is set;
- when the weekly timer is in use;

## Weekly Maintenance

Cleaning the original glass, the original cover, the scanning area and the guide area.

To maintain copy quality, the following items are recommended to be cleaned preferably once a week.

- **Clean the original glass with a cloth moistened with a small amount of water or cleaning liquid, then wipe a dry cloth over the glass.**

- Be careful not to scratch the parts that you are cleaning.

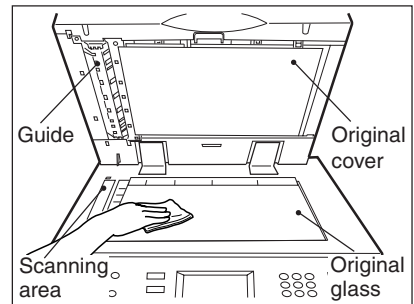



## 2. SIMPLE TROUBLESHOOTING

Check the following items, and if the problem still occurs, call service for assistance.

### Copier does not start

Items to be checked	Countermeasure	Reference page
Is the power cord plug firmly inserted in the outlet?	Insert the power cord plug firmly.	
Is the front cover, the side cover and the large capacity feeder (optional) firmly closed?	Close the covers properly.	Page 1-2

### Display does not change when keys or icons are pressed

Is the copier in the automatic energy saving mode?	Press the  START or  ENERGY SAVER key on the control panel to clear the automatic energy saving mode. (It takes a while for the copier to become ready.)	Page 1-5, 5-16
Is the power 'OFF' because the weekly timer is functioned?	Press  START key to return the power 'ON'.	Page 5-13
Is the account number keyed in? Is the account number correct?	Key in the correct account number. * If the account number is not clear, ask your copier manager.	Page 5-19
Is the "Warming up" message displayed?	Wait until the copier becomes ready.	Page 1-8

### Copy density is too low

Items to be checked	Countermeasure	Reference page
Has the message "Add toner" appeared on the screen?	Replace the toner cartridge.	Page 7-6
Is the copy density adjustment set lighter than is standard?	Use the manual density keys to set the copy density properly.	Page 3-11

## 2. SIMPLE TROUBLESHOOTING (Cont.)

### Copy density is too high

Is the copy density adjustment set darker than is standard?	Use the manual density keys to set the copy density properly.	Page 3-11
---	---	-----------

### Copies are stained

Is the reversing automatic document feeder firmly closed?	Close the reversing automatic document feeder firmly to shut out any outer light.	Page 2-10
Is the original cover or the transport belt of the reversing automatic document feeder dirty? Is the scanning area dirty?	Clean the original cover or the transport belt.	Page 8-2
Is the copy density set properly?	Set the copy density properly with the <b>AUTO</b> key or manual density keys.	Page 3-11

### Copy images are blurred

Items to be checked	Countermeasure	Reference page
Does the entire original lie properly on the surface of the glass?	Place the original firmly on the glass and close the reversing automatic document feeder.	Page 7-3
Is the copy paper moist?	Replace with new paper.	

### Images are partially missing

Are the original size and direction, as well as the reproduction ratio, suitable for the paper size?	Select the same size of copy paper as the original, or set the reproduction ratio suitable for the paper size.	Page 3-2, 3-4
Is the margin on the copy set properly?	Set a smaller image shift value.	Page 4-2

# 9. SPECIFICATIONS & OPTIONS

1. Specifications .....	9-2
2. Specifications of options .....	9-4
3. Packing list .....	9-6
4. Index .....	9-7

# 1. SPECIFICATIONS

Model Name	AR-651/810
Type	Console type
Original Glass	Fixed (original referenced to top left, referenced to center when using reversing automatic document feeder)
Copying System	Indirect electrophotographic method
Developing System	2-component magnetic brush developing
Fixing method	Heat roller (Induction heating)
Photoconductor Type	OPC
Original Scanning System	Linear CCD sensor
Resolution	600dpi x 2400dpi with smoothing
Acceptable Originals	Sheets, books and three-dimensional objects
Acceptable Original Size	LD, LG, LT, LT-R, ST-R, COMP, *1 A3, A4, A4-R, A5-R, B4, B5, B5-R, FOLIO
Acceptable Original Paper Weight	1-Sided Original: 13 - 34 lb. Bond *1 2-Sided Original: 13 - 28 lb. Bond
Acceptable Copy Paper Size	Drawer: LD, LG, LT, LT-R, ST-R, COMP, 13" LG, 8.5" SQ, A3, A4, A4-R, A5-R, B4, B5, B5-R, FOLIO, 8K, 16K, 16K-R (Tandem LCF: LT only) Bypass feeding: Paper size within 3.94" - 11.69" (Length), 5.83" - 17.01" (Width)
Acceptable Paper Weight	17 - 110 lb. Index (Drawer and Bypass feeding)
Warm-up Time	Approx. 160 seconds
First Copy Time (LT)	Approx. 3.2 seconds
Multiple Copying	Up to 9999 copies (digital key entry)
Reproduction Ratio	Actual size: 100 ± 0.5% Zoom: 25 - 400% (increments) For the reversing document feeder: 25 - 200% ( in 1% increments)
Paper Supply	Drawer: 500 sheets Tandem LCF: 2500 sheets (20lb. Bond) Sheets bypass: 100 sheets (20lb. Bond)
Toner Density Adjustment	Magnetic auto-toner system
Exposure Control	Automatic plus manual selection from 11 exposure step
Light Source	Xenon lamp
Power Requirements	115V, 50/60Hz, 20A
Power Consumption	AR-651/810: 2.0kw
Dimensions	27.48"(W) x 30.59"(D) x 47.76"(H) (copier only) 79.49"(W) x 30.59"(D) x 47.76"(H) (full options)
Weight	Approx. 463 lb. (copier only), Approx. 743 lb. (full options)
Space Occupied	55.16"(W) x 30.59"(D)
Storage Capacity	Max. 1000 images (1 job)

\*1 When using the reversing automatic document feeder.



**Continuous Copying Speed**

sheets/min.

Paper Type	Paper Size	Feeder	AR-651		AR-810	
			Face up	Face down	Face up	Face down
Plain Paper (17-20 lb. Bond)	LT, ST-R, 8.5" SQ, A4, A5-R, B5	Drawer/Tandem LCF	65	65	81	81
		Bypass	48	48	50	50
	LT-R, A4-R, B5-R	Drawer/Tandem LCF	50	48	61	56
		Bypass	42	42	44	44
	LG, COMP, 13"LG, B4, FOLIO	Drawer/Tandem LCF	43	40	52	45
		Bypass	37	37	39	39
	LD, A3	Drawer/Tandem LCF	37	34	43	37
		Bypass *2	33	33	34	34
Thick 1 ( - 90 lb. Index)	LT, ST-R, 8.5" SQ, A4, A5-R, B5	Drawer/Tandem LCF	65	65	81	81
		Bypass	48	48	50	50
	LT-R, A4-R, B5-R	Drawer/Tandem LCF	50	48	61	56
		Bypass	42	42	44	44
	LG, COMP, 13"LG, B4, FOLIO	Drawer/Tandem LCF	43	40	52	45
		Bypass	37	37	39	39
	LD, A3	Drawer/Tandem LCF	37	34	43	37
		Bypass *2	33	33	34	34
Thick 2 ( - 110 lb. Index)	LT, ST-R, 8.5" SQ, A4, A5-R, B5	Drawer/Tandem LCF	65	65	65	65
		Bypass	48	48	50	50
	LT-R, A4-R, B5-R	Drawer/Tandem LCF	50	48	50	48
		Bypass	42	42	44	44
	LG, COMP, 13"LG, B4, FOLIO	Drawer/Tandem LCF	43	40	43	40
		Bypass	37	37	39	39
	LD, A3	Drawer/Tandem LCF	37	34	37	34
		Bypass *2	33	33	34	34

\* The values above are measured when originals are set on the original glass, 1-Sided, 100% and non sort multicopies are made.

\* 'Face up' and 'Face down' in the table mean the paper exit faces.

\* The bypass copying speed is as listed above when specifying the paper size, however when the paper size is not specified, the copy speed of all sizes is on ' \*2'.

\* This specification varies depending on copying condition and environment.

## 2. SPECIFICATONS OF OPTIONS

### Finishers

Model Name	AR-F11	AR-F12		
Type	Floor type	Floor type		
Acceptable Paper Size	LD, LG, LT, LT-R, COMP, A3, A4, A4-R, B4, B5, FOLIO			
Acceptable Paper Weight	16 lb. Bond - 140 lb. Index			
Number of Copies Stapled at a Time (AR-F11, AR-F12)		20 lb.Bond	24 lb.Bond	28 lb.Bond
	LT, A4, B5	50 sheets	30 sheets	30 sheets
	LD, LG, LT-R, COMP, A3, A4-R, B4, FOLIO	30 sheets	15 sheets	15 sheets
Stapling Position	Rear, Front, Front diagonal, Double			
Saddle Stitch Unit	No	Yes		
Stitching Capacity		LD, LT-R, A3, A4-R, B4		
		20 lb.Bond	24 lb.Bond	28 lb.Bond
		15 sheets	10 sheets	10 sheets
Hole Punch Unit	Optional			
Power Source	Supplied from the copier			
Dimensions	24.2"(29.1" *) (W) x 24.8"(D) x 40.28"(H)			
Weight	Approx. 92.59 lb.	Approx. 136.7 lb.		
Power Consumption	170 W max.			

\* The values inside in parentheses are measured when the subtray is pulled out.

Units of inch  $\pm$  0.276inch

### Tray Loading Capacity

Values in parentheses = the number of 20lb. Bond sheets

Mode	Non-Sort		Sort/Group		Staples loaded	
					Mixed paper not loaded	Mixed paper loaded
Tray No.	1	2	1	2	1, 2	1, 2
ST-R, A5-R	2.9 (500)	2.9 (500)	x	x	x	x
B5-R	2.9 (500)	2.9 (500)	x	x	x	x
LT, A4, B5	9.8 (2000)	9.8 (2000)	9.8 (2000)	9.8 (2000)	Whichever of 4.3", 750 sheets or 50 copies is reached first	Whichever of 2.9", 500 sheets or 50 copies is reached first
LD, LG, LT-R, COMP, A3, A4-R, B4, FOLIO	5.5 (1000)	5.5 (1000)	5.5 (1000)	5.5 (1000)	Whichever of 2.9", 500 sheets or 50 copies is reached first	Whichever of 2.9", 500 sheets or 50 copies is reached first

**Hole Punch Unit**

Paper Weight : 16 lb. Bond - 140 lb. Index

	Number of punching holes and hole diameter	Available paper sizes
North America (AR-PN3B)	2 / 3 holes switchable (0.315" dia. )	2 holes: LG, LT-R 3 holes: LD, LT, A3, A4

**Inserter**

Model Name	AR-CF1	
Type	Floor Type	
Acceptable Paper Size	LD, LG, LT, LT-R, COMP, A3, A4, A4-R, B4, B5, FOLIO	
Acceptable Paper Weight	16 lb. Bond - 140 lb. Index	
Maximum Capacity	16 lb. Bond - 20lb. Bond	- 140 lb. Index
	100 sheets	Height: approx. 0.63"
	* Special paper: 60% less than above	
Power Source	Supplied from the copier	
Dimensions	21.0"(W) x 24.1"(D) x 42.2"(H)	
Weight	Approx. 6.2lb.	
Power Consumption	171W max.	

**External LCF (Large Capacity Feeder)**

Model Name	AR-LC4	
Type	Floor Type	
Acceptable paper size	LT	
Acceptable paper weight	17 lb. Bond - 110 lb. Index	
Maximum Capacity	4000 sheets (20lb. Bond)	
Power Source	Supplied from the copier	
Dimensions	12.8"(W) x 23.6"(D) x 24.3"(H)	
Weight	Approx. 88.2 lb.	
Power Consumption	1.5kW max. (with the copier)	

\* The paper mentioned above is Sharp-recommended paper. Specifications and appearance are subject to change without notice in the interest of product improvement.

### 3. PACKING LIST

Packing List	Operator's manual
	Photoconductive Drum
	Photoconductive Drum Cover
	Operator's manual Pocket
	Tray Spacer of Reversing Automatic Document Feeder
	Back guide for tab paper

\* Specifications and appearance are subject to change without notice in the interest of product improvement.

Acoustic Noise Emission (measurement according to ISO7779)

AR-651

	Printing mode	Printing mode with accessory*	Standby mode
Sound power level $L_{WA}$	X.X B	X.X B	X.X B

\* Accessory included in basic model

AR-810

	Printing mode	Printing mode with accessory*	Standby mode
Sound power level $L_{WA}$	X.X B	X.X B	X.X B

\* Accessory included in basic model

Emission Concentration (measurement according to RAL UZ62)

Ozone	less than 0.02 mg/m <sup>3</sup>
Dust	less than 0.075 mg/m <sup>3</sup>
Styrene	less than 0.07 mg/m <sup>3</sup>

# 4. INDEX

## Numbers

2 IN 1 .....	4-12
2 IN 1 DUPLEX .....	4-12
2 IN 1/4 IN 1 .....	4-12
4 IN 1 .....	4-12
4 IN 1 DUPLEX .....	4-12

## A

Acceptable Copy Paper Types and Sizes .....	2-4
Acceptable Original Types and Size .....	2-9
Account Numbers .....	5-19
Add Paper Symbol .....	7-3
Adding Paper to the Drawers .....	7-3
Adding Paper to the External LCF .....	7-5
Adding Paper to the Tandem LCF .....	7-4
Adding Staples .....	7-21
Additional Explanation .....	7-8
After Copying is Finished .....	1-9
Auto Job Start (Job Preset) .....	1-8, 2-13
Automatic CLEAR ALL .....	1-5
Automatic Copy Density Mode .....	3-11
Automatic Magnification Selection (AMS) .....	3-4
Automatic Paper Selection (APS) .....	3-2
Available Conditions for Saddle Stitch .....	6-7

## B

Book-type Originals .....	2-10
Book-type Originals to 2-Sided Copies .....	3-8
Bypass Copying .....	5-8
Bypass Copying on Non-Standard Size Paper ...	5-11
Bypass Copying on Standard Size Paper .....	5-10
Bypass guide .....	1-2

## C

Call Service Symbol .....	7-28
Canceling the Sharpness Adjustment .....	4-33
Changing a Specific Account Number .....	5-23
Changing the Paper Size of the Drawer .....	2-6
Changing the Printing Order .....	2-17
CLEAR key .....	1-4
CLEAR ALL key .....	1-5
Clear Paper Symbol .....	7-9
Clearing a Specific Account Number .....	5-25
Clearing All Counters .....	5-27
Clearing the Automatic Energy Saving Mode ..	5-16
Clearing the Drawer for Special Uses .....	2-8
Clearing the Functions Selected .....	1-7

Clearing the Off-Mode/Sleep Mode .....	5-17
Clip tray .....	1-5
Confirming and Canceling Auto Job Start .....	2-13
Confirming Stored Copy Modes .....	5-7
Confirming Stored Image (Test Print) .....	4-31
Continuous Copying Speed (Specification) .....	9-3
Continuous Feed Mode .....	5-2
Continuous Original Feeding/Single Original Feeding .....	5-2
Control Panel .....	1-4
Controlling the Use of the Copier with Account Numbers .....	1-9
Copier does not start .....	8-3
Copies are stained .....	8-4
Copy Density Adjustment .....	3-11
Copy density is too high .....	8-4
Copy density is too low .....	8-3
Copy images are blurred .....	8-4
COPY key .....	1-4
Copying Procedure .....	2-2
Copying when the power is off .....	5-13
Copying with Annotation .....	4-14
Correcting Entered Letters .....	5-29
Cover Copying .....	4-18
Cover Sheet Insertion of Top Blank/Both Blank	6-11

## D

Daily Inspection .....	8-2
Deleting a Specific Account Number .....	5-24
Deleting Image .....	4-31
Deleting or Changing Order of Pending Jobs ..	2-16
Deleting the Job .....	2-16
Description of the Digital Copier and the Optional Equipment .....	1-2
Description of the Flashing Graphic Symbols ..	7-2
Digital keys .....	1-4
Direction of Duplex Copy Images .....	4-34
Disabling a Account Number .....	5-26
Disclaimer Notice .....	6
Display does not change when keys or icons are pressed .....	8-3
Dispose of Used Toner .....	7-8
Disposing of Accumulated Punched Paper Bits ..	7-27
Document Storage .....	4-28
Drawers .....	1-2
Dual Page .....	4-5

## 4. INDEX (Cont.)

Duplex Copying .....	3-7	<b>J</b>	Job Memory .....	5-5
<b>E</b>			JOB STATUS key .....	1-4
Edge Erase .....	4-4	<b>L</b>		
ENERGY SAVER key .....	1-5		Large Capacity Feeder .....	1-3
Entering Letters .....	5-28		Large Capacity Feeder (Specification) .....	9-5
Exit cover .....	1-2	<b>M</b>		
Exiting Copy Papers .....	2-3		Magazine Sort .....	4-16
Exiting Originals .....	2-11		MAGAZINE SORT & SADDLE STITCH key ....	6-6
External LCF .....	9-5		Magazine Sort & Saddle Stitch Mode .....	6-6
<b>F</b>			MAGAZINE SORT key .....	6-6
Feed side cover .....	1-2		Main Components .....	1-2
Finisher .....	1-3, 7-21, 7-24		Making Copies in the PRINT Mode .....	4-29
Finisher (Specification) .....	9-4		Manual Copy Density Mode .....	3-12
Finishing Mode and Finishers .....	6-2		Manual Paper Selection .....	3-3
Fixing the adjusters (stoppers) .....	10		Master number registration .....	5-19
Front cover .....	1-2		Maximum Number of Sheets that can be Stapled .	6-5
Function setting area .....	1-6		Mirror Image .....	4-10
<b>G</b>			Mixed-Sized Originals .....	5-4
General Copying Procedures .....	2-2	<b>N</b>		
General Precautions .....	8		Names of the Main Components .....	6-2
<b>H</b>			Negative/Positive Reversal .....	4-11
Handing and Storing Paper .....	2-5	<b>O</b>		
HELP key .....	1-4		Operator's manual pocket .....	1-2
Hole Punch Mode .....	6-8		Optional Equipment .....	1-3
Hole punch unit .....	1-3		Original glass .....	1-2
Hole Punch Unit (Specification) .....	9-5		Original scale .....	1-2
<b>I</b>			Overlay .....	4-30
Image Editing .....	4-8		Overlaying Originals with Stored Image .....	4-32
Image Shift .....	4-2	<b>P</b>		
Images are partially missing .....	8-4		Packing List .....	9-6
In the Continuous Feed Mode .....	2-12		Page Numbering Copying .....	4-15
In the Single-feed Mode .....	2-12		Paper Selection .....	3-2
Index keys .....	1-6		Paper size indicator .....	1-2
Insertor .....	1-3		Paper Misfeed inside of the Copier .....	7-12
Insertor (Specification) .....	9-5		Paper Misfeed in the External LCF .....	7-15
Insertor Mode .....	6-9		Paper Misfeed in the Finisher .....	7-18
Installation (Precautions) .....	7		Paper Misfeed in the Hole Punch Unit .....	7-17
Interrupt Copying .....	2-14		Paper Misfeed in the Insertor .....	7-16
INTERRUPT key .....	1-5		Paper Misfeed in the Reversing Automatic Document Feeder .....	7-10
Items for Daily Check .....	8-2			

Paper Misfeed in the Saddle Stitch Unit AR-F12 .....	7-19	Setting the Inserter .....	6-10
Paper Misfeed on the Bypass Guide .....	7-15	Sharpness Adjustment .....	4-33
Papers Acceptable to Set in the Inserter .....	6-9	Sheet Insertion .....	6-12
Periodic Maintenance Message .....	7-28	Sheet Insertion Copying .....	4-20
Power switch .....	1-2	Sheet Originals .....	2-10
Precautions .....	7	Simple Troubleshooting .....	8-3
Precautions for Using the Reversing Automatic Document Feeder .....	2-11	Single-feed Mode .....	5-3
Print out account number .....	5-27	Sort/Group Copying .....	6-3
PRINTER/NETWORK key .....	1-4	Specifications .....	9-2
Procedure to display the account number menu ....	5-20	Specifications of Options .....	9-4
Providing a Bookbinding Margin .....	4-3	Specifying both Original Size and Copy Size ..	3-5
Providing Right or Left Margin .....	4-2	Staple Sorting .....	6-4
<b>Q</b>		START key .....	1-5
Quick Access Menu .....	3-14	STOP key .....	1-5
<b>R</b>		Stopping the Copy Operation .....	2-15
Recalling a Stored Combination of Copy Jobs to Make Copies .....	5-6	Stopping the Multicopying Operation .....	2-15
Reduction and Enlargement Copying .....	3-4	Stopping the Scanning of the Original .....	2-15
Registering a New Account Number .....	5-21	Storing a Combination of Copy Jobs Settings .	5-5
Remaining paper level .....	1-6	Storing a Non-Standard Size in the Memory .	5-12
Removing Jammed Staples .....	7-24	Storing Documents in the MEMORIZE Mode	4-28
Replace Toner Bag .....	7-8	Storing Image .....	4-30
Replace Toner Cartridge Symbol .....	7-6	Switching Languages .....	5-18
Reversing automatic document feeder .....	1-2	<b>T</b>	
<b>S</b>		Tab Paper Copying .....	4-25
SADDLE STITCH key .....	6-6	Tab Paper Insertion .....	4-26
Saddle Stitch Mode (Booklet mode) .....	6-6	Tab Paper Insertion and Copying .....	4-27
Saddle Stitch Unit .....	7-22, 7-25	Tab Paper Mode .....	4-22
Selecting Original Mode .....	3-13	Tab Width Adjustment .....	4-23
Set functions confirmation key .....	1-7	TIMER lamp .....	1-5
Setting Copy Paper .....	2-4	Toner cartridge .....	1-2
Setting Originals .....	2-9	Touch Panel .....	1-4, 1-6
Setting Paper .....	6-9	Transfer unit .....	1-2
Setting Tab Paper in the Bypass Guide .....	4-23	Tray Loading Capacity (Specification) .....	9-4
Setting Tab Paper in the Drawer .....	4-22	Trimming/Masking .....	4-8
Setting the "Other" Size Key .....	5-14	Transfer unit lever .....	1-2
Setting the Automatic Energy save mode .....	5-16	Turning ON the Power Switch .....	1-8
Setting the Automatic Off-Mode .....	5-17	<b>U</b>	
Setting the Drawer for Special Uses .....	2-7	Using only Stapling and Hole Punch .....	6-13
Setting the Clock to the Daylight Saving Time	5-15	Using the Reduction/Enlargement Zoom Keys or One-touch Zoom Keys .....	3-6
Setting the Date and Time .....	5-15	<b>W</b>	
		Weekly Maintenance .....	8-2
		Weekly Timer .....	5-13

## 4. INDEX (Cont.)

---

When Coming Across the Situations below .....	2-3
When Placing an Original on the Glass .....	2-10
When this message appears: "Wait" .....	2-3
When Using the Reversing Automatic Document Feeder .....	2-11

### **X**

X-Y Zoom .....	4-7
----------------	-----



## **NOTICE**

BE SURE TO ASK YOUR AUTHORIZED SHARP DEALER ABOUT THE WARRANTY THAT YOUR SELLING DEALER EXTENDS TO YOU. In order to assure you, the end-user, of warranty protection, Sharp extends a limited warranty to each of its authorized dealers and, in turn, requires each of its authorized dealers to extend its own warranty to you on terms that are no less favorable than those given to the dealer by Sharp. You should be aware, however, that Sharp does not itself extend any warranties, either express or implied, directly to you, the end-user and no one is authorized to make any representations or warranties on behalf of Sharp. Specifically, SHARP DOES NOT EXTEND TO YOU, THE END-USER, ANY EXPRESS WARRANTY OR ANY IMPLIED WARRANTY OF MERCHANTABILITY, FITNESS FOR USE OR FITNESS FOR ANY PARTICULAR PURPOSE IN CONNECTION WITH THE HARDWARE, SOFTWARE OR FIRMWARE EMBODIED IN, OR USED IN CONJUNCTION WITH THIS PRODUCT. Sharp is not responsible for any damages or loss, either direct, incidental or consequential, which you, the end-user, may experience as a result of your purchase or use of the hardware, software or firmware embodied in or used in conjunction with this Product. Your sole remedy, in the event that you encounter any difficulties with this Product, is against the authorized dealer from which you purchased the Product.

In the event that this authorized dealer does not honor its warranty commitments, please contact the General Manager , Business Products Group, Sharp Electronics Corporation, Sharp Plaza, Mahwah, NJ 07430-2135, so that Sharp can try to help assure complete satisfaction of all the warranty rights to which you are entitled from the authorized dealer

**SHARP**<sup>®</sup>

**SHARP ELECTRONICS CORPORATION**

Sharp Plaza, Mahwah, New Jersey 07430-2135.

[www.sharp-usa.com](http://www.sharp-usa.com)

**SHARP ELECTRONICS OF CANADA LTD.**

335 Britannia Road East, Mississauga, Ontario, L4Z 1W9

**SHARP CORPORATION**